

ROBAND®

Manufactured By
ROBAND AUSTRALIA PTY LTD



OPERATING INSTRUCTIONS

SYCLOID™ TOASTER

Models: **ST500A** **Version 2**
 ST350A **Version 2**

Includes:

Alternative Colours: ...R, ...B
International models: ...-Gxx, ...-Fxx, & ...-Mxx

Special Features:

- Cool to Touch for User Safety
- Hinged Lid For Easy Cleaning
- Advanced Automatic Electronic Controls
- Automatic Bread Sensing
- Energy Saving Mode
- Ultra-Durable Stainless Steel Elements
- LED Lights Illuminating Toast Chute
- Easy Clean Crumb Tray



These instructions cover the models of ROBAND® Conveyor Toasters only. Although there are slight variances between models, the installation, operation, care and maintenance procedure is the same for all.

Roband® Australia is a wholly Australian owned company and has been manufacturing quality commercial catering equipment for the food service industry for more than 50 years. Roband products are engineered and manufactured to the highest standards to provide functionality, reliability and durability, and our quality products are exported world-wide.

Included in the comprehensive Roband® range are Toasters, Fryers, Milkshake Mixers, Rotisseries, Food Display Cabinets and much more.

Roband® Australia also acts as the Australian agents for Vitamix® Blenders, Noaw® Meat Slicers, Förje® Cookware, Robalec™ Soup/Rice Warmers, Robatherm Urns, Austheat® Fryers, Dipo Induction & Autofry Machines. Roband also has its own line of commercial cookware and cutlery under the Robinox® brand name.

For a complete set of brochures please contact your nearest authorised dealer or contact Roband directly at our head office.

Roband Head Office Sydney, Australia			
Roband Australia Pty Ltd 1 Inman Road Dee Why NSW 2099 AUSTRALIA		Tel: +61 2 9971 1788 Fax: +61 2 9971 1336 Email: sales@roband.com.au Web: www.roband.com.au	
International Agents For additional agents please email Head Office			
Belgium	Linum Europe Ph: +32 (0)56 35 92 96	Noumea:	Comptoir Materiel Professionnel Ph: +687 28 50 43
Fiji:	Hotel Equipment Ltd Ph: +679 672 0666	Papua New Guinea:	Brian Bell & Company Pty Ltd Ph: +675 325 5411
Germany	Lolsburg Ph: +49 93059878-0	Singapore:	Allied Foodservice Equipment Ph: +65 62525880
GREECE	K&N Engineers Ltd Ph: +30 210 520 0440	South Africa	Foodservice Solutions (Pty) Ltd Ph: +31 306 017 442
Hong Kong:	Chung Wah Kitchen Machine Ltd Ph: +852 2334 5411	Thailand:	Seven Five Distributors Co Ltd Ph: +662 866 5858
Italy	NOAW Ph: +39 0331 219723	United Kingdom	Metcalfe Catering Equipment Ph: +44 (0) 1766 830456
Malaysia:	Allied Food Equipment Ph: +603 9133 5833	United Arab Emirates:	Boncafe Middle East LLC +9714 282 8742
Maldives:	Radiant Heat Maldives Pty Ltd Ph: +960 333 4845	United Arab Emirates:	Nisa Trading LLC +9714 396 6132
New Zealand:	Roband New Zealand Ph: +649 274 1354	U.S.A.	Smart Kitchen Solutions Ph: +1 508 244 1365

© Copyright 2015 – Roband® Australia Pty Ltd

All rights reserved. No part of this work may be reproduced or copied in any form or by any means, electronic or mechanical, including photocopying or posting to a website, without the written permission of the publisher. The material contained within this document is intended entirely for instructional purposes.

CONTENTS

INTRODUCTION	1
GENERAL PRECAUTIONS	1
PACKAGE CONTENTS.....	2
COMPLIANCE	2
INSTALLATION	3
OPERATION.....	5
GENERAL SAFETY	9
CLEANING, CARE & MAINTENANCE	10
TROUBLESHOOTING.....	12
SENSOR TEST MODE	13
SPECIFICATIONS.....	13
APPENDIX A	14
WARRANTY	15

INTRODUCTION

Congratulations on your purchase of this quality ROBAND® product. With proper care and management your new purchase will give you years of trouble free service.

By reading these instructions carefully you can ensure that this machine is used and maintained properly, helping your new investment to perform well for you now, and to continue performing in the many years to come.

GENERAL PRECAUTIONS

This machine must only be operated by qualified person(s) who are fully versed in the operating and safety instructions described in this manual. Service personnel should be instructed to familiarise themselves with any and all safety instructions described in this manual prior to commencement of any maintenance or service.

In the case of new personnel, training is to be provided in advance. These machines should not be operated by persons (including children) with reduced physical, sensory or mental capabilities, or lack of experience or knowledge, unless they have been given supervision or instruction concerning the safe use of the appliance by a person responsible for their safety.

 These machines are heating units, and as with any commercial heating unit the surfaces on these Toasters will get hot. Always be careful when near an operating Toaster, and ensure that any risk to unwary customers or staff is minimised with additional signage if necessary. Due to the obvious heat hazard Roband recommends that these units be kept out of reach of children. Do not allow children to play with these units.

These Toasters are for use with bread products without spreads or fillings. The performance of this unit cannot be guaranteed for non-bread product such as Pizza, or for unusually thick bread products.

 The machine should be disconnected from all power and allowed to cool before cleaning.

Roband will accept no liability if;

- ◆ Non-authorized personnel have tampered with the machine.
- ◆ The instructions in this manual have not been followed correctly.
- ◆ Non-original spare parts are used.
- ◆ The machine is not cleaned correctly, with the right product.
- ◆ There is any damage to the unit.
- ◆ The machine has been modified in any way.

PACKAGE CONTENTS

All care is taken when packing and Roband ensures that every unit is functional and undamaged at the time of packaging.

The Package of this Conveyor Toaster should include:

- 1) One Sycloid™ Conveyor Toaster (appropriate model)
- 2) One Crumb Tray
- 3) This Manual

Any damage to the machine as a result of freight must be reported to the Freight Company and to the agent responsible for the dispatch of said unit within 24 hours of receipt. No claims will be accepted or entertained after this period.



RCM:

Roband® products have been designed and manufactured to comply with any and all specifications set out by the Australian Communications and Media Authority (ACMA) in regards to Electromagnetic Compatibility. As testament to such compliance these units bear the RCM symbol.

For further information contact the Australian Communications Authority, PO Box 13112, Law Courts, Melbourne VIC 8010.

CE:

Roband® products bearing the CE compliance mark have been designed and manufactured to comply with European Standards and Directives

INSTALLATION

Remove all the packaging materials, tape and all protective plastic from the machine. Clean off any glue residue left over from the protective plastic using methylated spirit.

Place the toaster on a firm level surface in the required position.

The toaster is insulated and contains an internal cooling fan so that it remains safe to touch externally while operating. Good ventilation is required for this to function correctly.

Please ensure that there is 50mm clearance on each side and 100mm clearance at the back of the toaster as a minimum. If the toaster is situated near other hot equipment these clearances should be increased accordingly.

For access to the toast chute ensure that any nearby objects on the side of the toaster don't intrude forward of the side openings blocking access to remove toast.

It is preferable that the toaster is placed in a position so that it is clear on all sides. The clearances shown should be used as an absolute minimum. Always strive towards greater clearances.

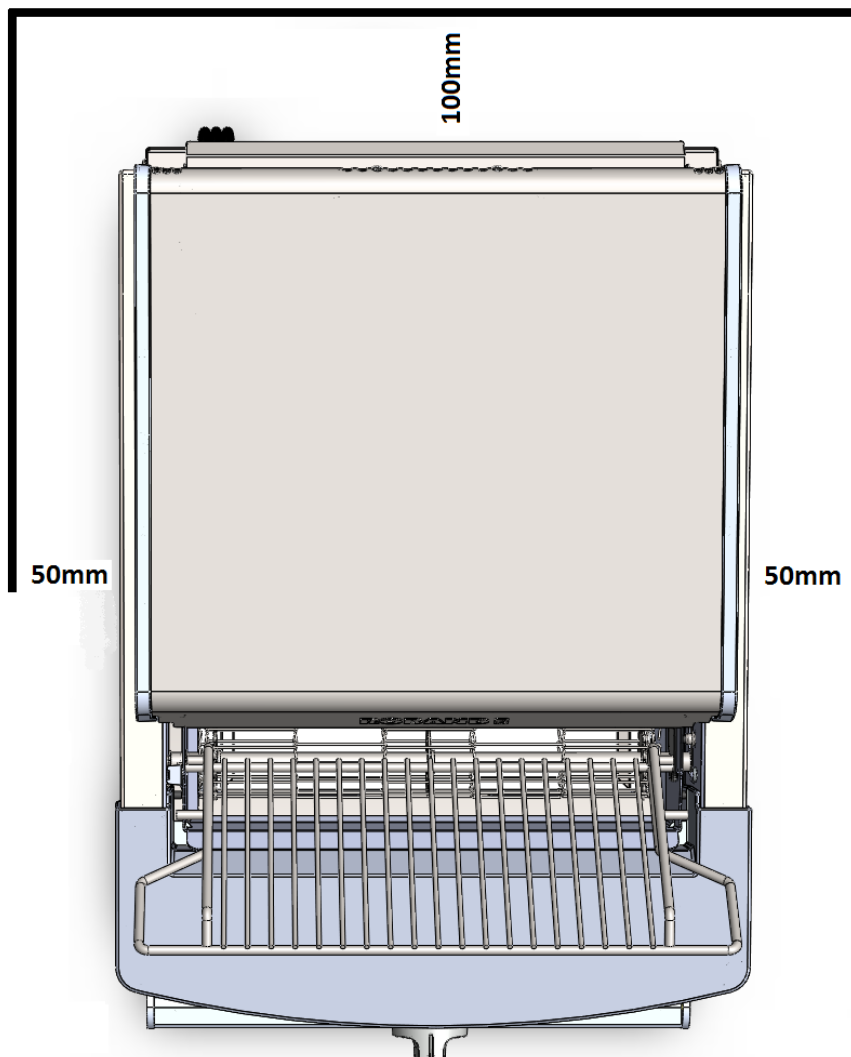

Figure 1: Minimum Installation Clearances

NOTE: The toaster is not designed to be installed on top of other cooking equipment.

Remove the crumb tray packaging and insert the crumb tray into the toaster. If it has been removed for cleaning, please ensure that it has been replaced prior to use.

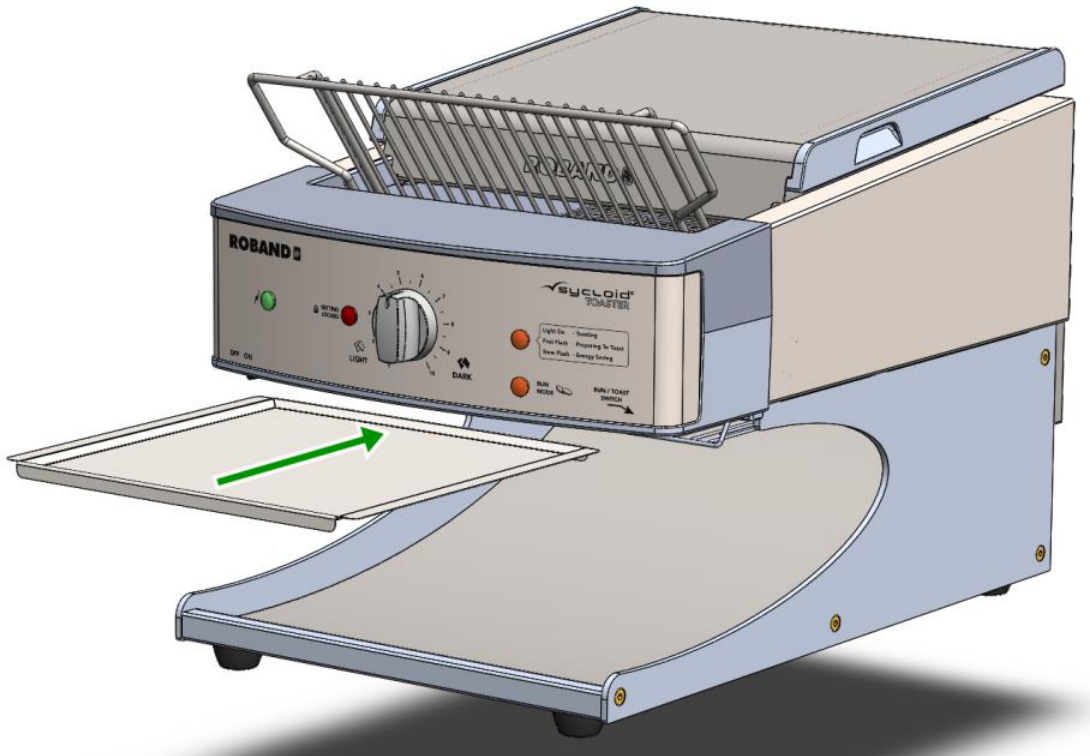

Figure 2: Install the Crumb Tray

MAINS POWER

Before connecting the toaster to the mains power supply, ensure that the controls are in the **OFF** position.

⇒ AUSTRALIAN MODELS

ST350A: Plug the toaster into a standard single phase 10 amp power point.

ST500A: Plug the toaster into a standard single phase 15 amp power point.

⇒ INTERNATIONAL MODELS

ST350A-GXX and ST500A-GXX: Plug the toaster into a standard 13 amp UK power point, Type G.

ST350A-FXX and ST500A-FXX: Plug the toaster into a standard 16 amp European power point, Type F.

ST350A-MXX and ST500A-MXX: Plug the toaster into a standard 15 amp South African power point, Type M.

The machine is now ready for operation. Please read the next section for further information.

OPERATION

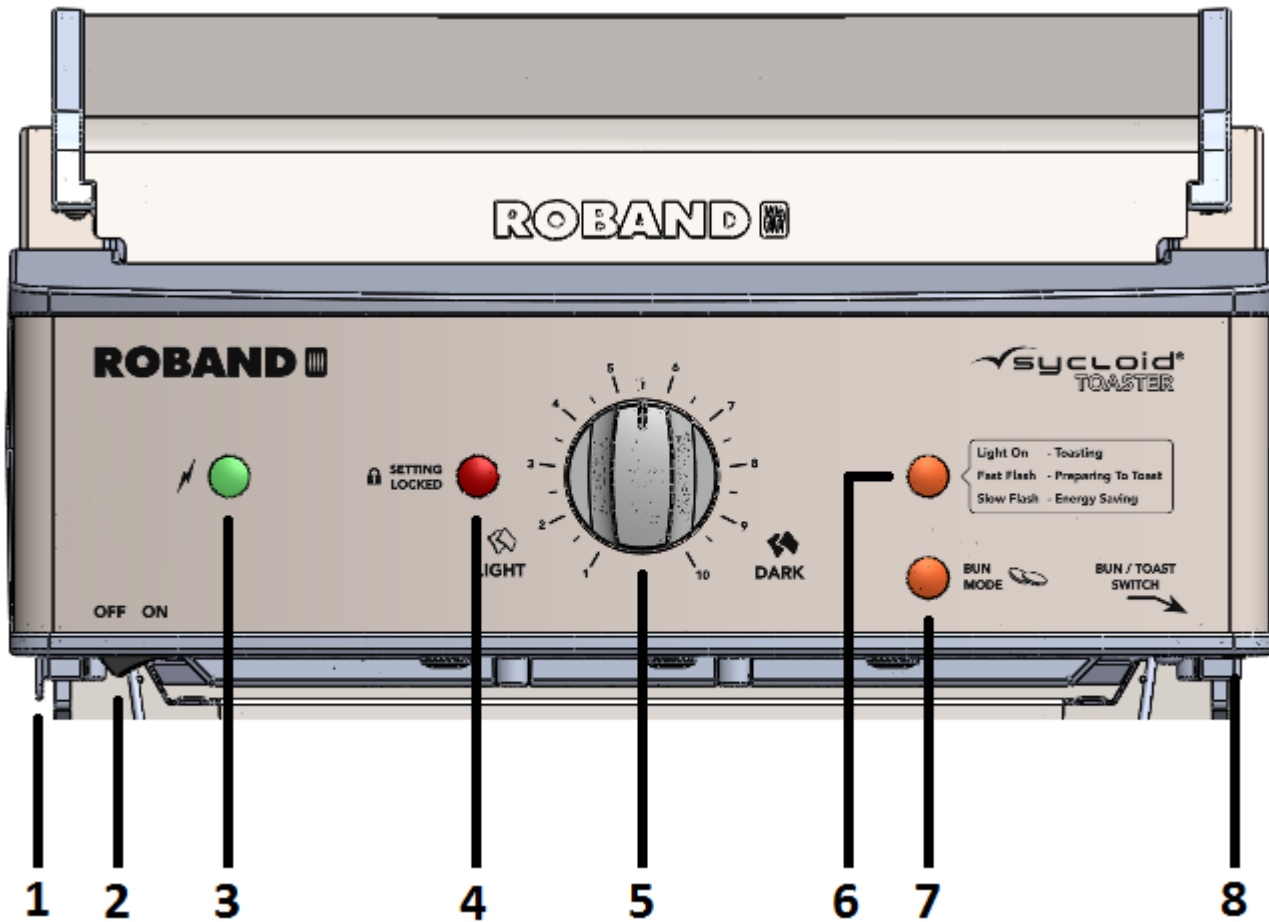

Figure 3: Control Panel

Front Panel Controls

Item	Description	Function
1	Top Cover Latch	Pull to release and open top cover
2	Main On/Off Switch	Switches toaster on and off
3	Green Pilot Light	Indicates power is on
4	Red Pilot Light	Indicates conveyor speed is locked
5	Speed Control Knob	Changes speed of conveyor
6	Toasting Amber Pilot Light	Indicates toasting and energy saving
7	Bun Mode Amber Pilot Light	Indicates bun mode is active
8	Bun Mode Switch	Switches bun mode on and off

SWITCHING YOUR TOASTER ON

The main on/off switch is located at the front left hand side of the machine on the underside of the front housing. After switching on, the green pilot light will indicate the machine is on.

WARM UP CYCLE

After switching on, the toaster will begin its Warm-Up Cycle. During warm up, the elements will be powered at 100% and the amber pilot light will flash quickly.

The conveyor will switch on after 3 minutes of warm up. The toaster takes about 10 minutes to reach a constant cooking temperature.

Note: As a safety precaution the toaster will start in Normal Operation mode and will not warm up if the main switch is on when the mains power is supplied.

NORMAL OPERATION

After the warm-up cycle, the toaster is ready to use. The amber pilot light and the conveyor will remain on.

The toaster will remain in normal operation mode as long as it is being used. A sensor monitors when bread is placed on the bread chute. If the toaster has not been used for a period of time it will automatically enter into three stages of energy saving modes.

TOASTING

Set the speed control knob to about 5 as an initial speed setting. Place 1 or 2 slices of bread on the bread chute and check the results when finished.

Adjust the speed control if required. This can be adjusted faster or slower to achieve lighter or darker cooking as required.

SPEED LOCKING

If desired, the toaster can be locked at any conveyor speed.

To lock a conveyor speed, perform the following steps.

1. Rotate the speed control knob fully to the left, then fully to the right, rapidly, and keep repeating until the red pilot light flashes quickly.
2. While the red pilot light is flashing set the conveyor speed to the desired position and release the knob.
3. After 10 seconds of no rotation the speed will be locked to the set position and the red pilot light will remain on indicating that the speed is locked.

To unlock a locked conveyor speed, perform the following steps.

1. Rotate the speed control knob fully to the left, then fully to the right, rapidly, and keep repeating until the red pilot light is switched off.
2. The conveyor will be unlocked and the red pilot light will switch off.

BUN MODE

If you want to toast buns you can place the toaster into Bun Mode.

The bun mode switch is located at the front right hand side of the machine on the underside of the front housing.

When bun mode is switched on the element power will be reduced to a level suitable for buns and the amber bun mode pilot light will be switched on.

Note: The toaster is designed for buns up to 110mm diameter and 30mm thick. Be sure to load your buns on the chute with the cut face up.

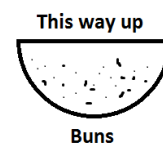

Cooking will continue in this configuration as it does in normal operation, however, the energy saving features will be disabled.

ENERGY SAVING

During normal operation the toaster monitors toasting activity. If the toaster detects that activity has stopped, it will gradually shut down in three stages as follows.

1 Motor Saving Mode

After the toaster has been idle for a period of 5 minutes the conveyor motor turns off to save energy. The elements will remain on. The conveyor automatically restarts when bread is placed on the chute.

2 Energy Saving Mode

After the toaster has been idle for a period of 30 minutes, it will enter Energy Saving Mode.

During energy saving mode the element power is reduced to save power and the conveyor remains off. This will be indicated by the flashing toasting amber pilot light. The toaster automatically wakes up from energy save mode when bread is placed on the chute.

When waking up from energy save mode the elements will be switched back to 100% power. The amber pilot light will flash quickly the same way it does when the toaster warms up. The conveyor will move the bread into the cooking cavity, and will index on and off until full operating temperature has been reached. When at full temperature the conveyor will move continuously.

3 Sleep Mode

After the toaster has been idle for a period of 70 minutes it will enter Sleep Mode.

During sleep mode the elements are shut down completely and the conveyor will remain off. This will be indicated by the flashing toasting amber pilot light. The toaster automatically wakes up from sleep mode when bread is placed on the chute.

When waking up from sleep mode the toaster enters into a full warm up cycle in the same way it does when the toaster is turned on for the first time at the start of operation.

FAULT MODES

In the event of a fault, the machine will enter Fault Mode.

During fault mode, power to the elements and the conveyor will be shut down until the fault is rectified.

Some lights will flash depending on the fault. Please check the Troubleshooting section for help on identifying a fault.

1 Cover Open

If the cover is opened during operation, power to the elements and the conveyor will be turned off immediately. The toasting amber and red pilot light will flash alternately.

When the cover is closed the machine will resume normal operation.

The cover should not be opened during normal operation, only when cool.

2 Motor Failure

If the motor fails, power to the elements will be turned off immediately. The toasting amber and red pilot light will flash together.

Call for assistance from a licensed service agent.

3 Over Temperature

If the toaster cooling system is compromised and the internal temperature reaches 80°C, power to the elements will be turned off immediately and the conveyor will continue to run so that nothing is left inside the cooking cavity.

The toasting amber pilot light, red pilot light and LED light strip will flash together.

Allow the machine to cool down before trying to cook again. If the problem persists, call for assistance from a licensed service agent.

STANDBY (OFF) MODE

When switched off the toaster goes to standby mode. The green pilot turns off. The cooling fan will continue to run on for period of about 10 minutes to cool the toaster.

During standby the toaster will consume a very small amount of power (<10W). It is recommended that the machine be disconnected from mains power when not in use.

OPERATING TIPS

- ⇒ Best results are obtained by using day old bread, which has lost some of the moisture inherent with fresh bread.
- ⇒ Different breads will have different toasting properties. Using the same brand of bread will result in more consistent toasting through user familiarisation.
- ⇒ When you establish your desired cooking level consider locking the speed to ensure consistent results.
- ⇒ Regular cleaning of the crumb tray is essential.
- ⇒ When toasting buns make sure you load the buns with the cut face up.

⚡ SAFETY ⚡

GENERAL SAFETY

This machine contains no user-serviceable parts. Roband Australia, one of our agents, or similarly qualified personnel should carry out any and all repairs. Any service personnel should be instructed to read the Safety warnings within this manual before commencing work on these units.

 Steel cutting processes such as those used in the construction of this machine may result in sharp edges. Whilst any such edges are removed to the best of our ability it is always wise to take care when contacting any edge. Do not remove any screwed cover panels that may be on the machine.

 This unit can get **very** hot inside the toast cavity. Do not open the top cover or remove crumb tray whilst the machine is hot. Do not place your hand into the entry of the toast cavity. There is a wire guard above the toast chute area, do not intentionally touch this guard or any part it covers.

 Always ensure the power cable does not run next to or behind other hot machines. Ensure that any damaged power cord is replaced before further use. These cords should be replaced by qualified service persons only.

 Do not clean this unit with the use of a water jet. Do not clean with a soaking wet cloth or sponge. Do not immerse the machine into water.

 Do not move the machine while the top cover is opened. Only move the machine when the top cover is closed and the machine has cooled down. The machine should be transported on a trolley and not carried.

CLEANING, CARE & MAINTENANCE

Attention to regular care and maintenance will ensure long and trouble free operation of your toaster. Although scheduled servicing is not required we do recommend you adopt a program of regular maintenance to ensure that the toaster is clean and functional and to avoid inadvertently damaging the unit.

- ⇒ Ensure the **power is disconnected** and the **toaster is cool** before attempting to clean any part of the machine.
- ⇒ Daily cleaning of the crumb tray is a requirement. The crumb tray may be removed by sliding it out from the toaster. It can then be emptied. Be sure to put the crumb tray back into the unit.
- ⇒ All toasters will begin to look dirty if not cleaned daily. In order to maintain its attractive appearance the Sycloid Toaster has been specifically designed to allow for easy cleaning. **Roband recommends cleaning daily.**
- ⇒ To clean;
 - Remove the crumb tray and empty.
 - Open the top cover and brush any excess dried crumbs from the inside of the toast cavity, lower elements and lower reflector. Brush the dried crumbs out of off the toast chute.
 - Wipe the outside of the toaster down with warm soapy water using a **damp** sponge or cloth. **Do not** immerse the toaster in water or allow the ingress of water into the ventilation holes or controls. **Do not** clean this unit with the use of a water jet.
 - Close the cover before wiping the outside of it down.
 - Wipe the toast chute out.
 - Ensure that the crumb tray is replaced prior to use.



CAUTION: Although every care is taken during manufacture to remove all sharp edges, care should be taken when cleaning and handling the toaster to avoid injury.



CAUTION: Some cleaning agents can damage stainless steel, aluminium and plastic, usually through prolonged use. **For this reason we recommend cleaning with soapy water only** with a **damp** sponge or cloth. Any damage to the unit through the use of harsh or improper cleaning agents is not the responsibility of Roband.

OPENING THE COVER

Pull the cover release lever on the left hand side of the machine. With the other hand swing the top cover fully open. Do not move or bump the machine whilst the cover is open.

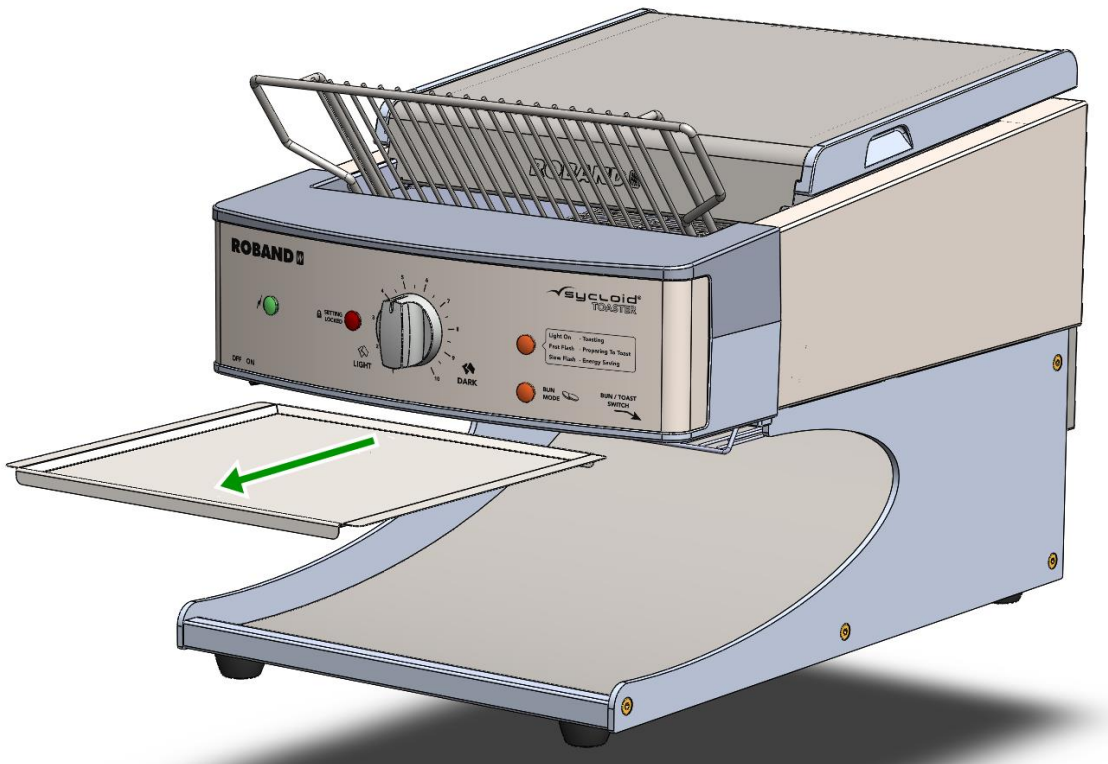

Figure 4: Remove the Crumb Tray

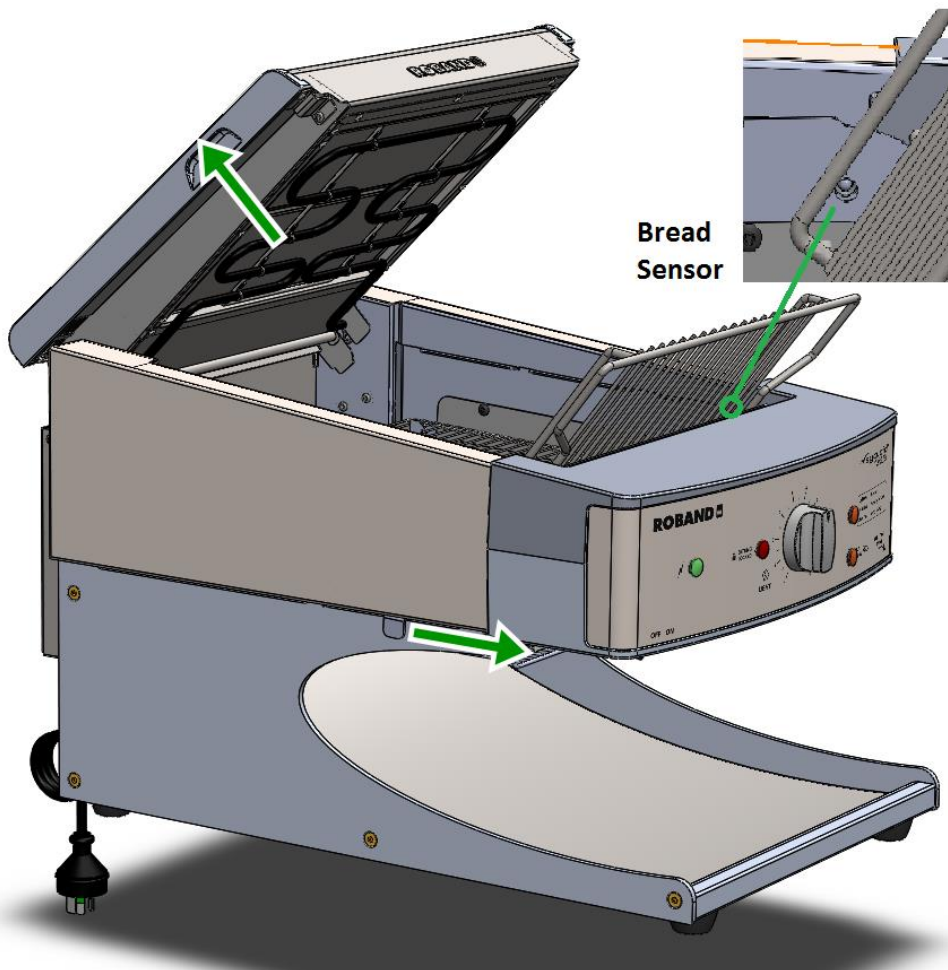

Figure 5: Open the Top Cover

TROUBLESHOOTING

Check all the following points before contacting a service agent.

If the Toaster does not start:

- ✓ The power point is not faulty.
- ✓ The machine is plugged in correctly and the power switched on.
- ✓ The Lid is in the closed position. The amber and red pilots will flash alternatively if the lid is opened.
- ✓ The ON – OFF switch is switched on. The green pilot light should be on.

If the conveyor stops during operation:

- ✓ The machine may be in energy saving mode. Check the flash condition of the amber pilot. Put bread in and see if it will start automatically.
- ✓ If smoke is coming from the cooking cavity, turn off the machine and allow it to cool. Open the top cover and check for anything stuck in the conveyor.

If the machine does not enter Energy Save mode:

- ✓ Check the bread sensor works (see Sensor Test Mode). Note that if the bread sensor does not work the machine will never go into energy saving mode.

If the machine trips the RCD:

- ✓ Check Appendix A at the end of this manual on the subject of RCD's.

Indicating Lights

Use this table to help diagnose the machine status.

Status	Amber Cook	Red	Chute Lights
Warm Up	QUICK FLASH	OFF	ON
Normal	ON	OFF	ON
Speed Locking	ON	QUICK FLASH	ON
Speed Locked	ON	ON	ON
Speed Unlocked	ON	OFF	ON
Motor Save	ON	OFF	ON
Energy Save	1 SECOND FLASH	OFF	ON
Sleep	2 SECOND FLASH	OFF	ON
Cover Open	1 SECOND FLASH ALTERNATELY		ON
Motor Failure	2 SECOND FLASH TOGETHER		ON
Over Temp.	4 SECOND FLASH TOGETHER		
Sensor Test: Beam blocked	ON	DOUBLE FLASH	OFF
Sensor Test: Beam unblocked	OFF	DOUBLE FLASH	OFF

SENSOR TEST MODE

STEP 1: Place the machine in Sensor Test Mode.

This test can be used to test the operation of the bread sensor and conveyor motor.

CAUTION: Ensure the toaster is cold. **Do not** use this procedure if the toaster is hot.

- ⇒ Switch the machine OFF.
- ⇒ Open the top cover using the release lever located on the left hand side. The elements will not activate while the cover is opened.
- ⇒ Switch the main switch on and off 5 times rapidly. The action is as follows:
ON – OFF – ON – OFF – ON – OFF – ON – OFF – ON
This needs to be done in about 5 seconds to complete the action successfully.
- ⇒ Upon entering the Sensor Test Mode the red pilot light will double flash.
- ⇒ Block the bread sensor beam by pushing the bread chute away from you so that it is in front of the hole near the bottom right hand side of the bread chute.
 - While the bread sensor beam is blocked, the conveyor motor will start moving and the amber pilot light will turn on.
 - While the bread sensor beam is unblocked, the conveyor motor will stop moving and the amber pilot light will turn off.

STEP 2: Place the machine back in normal mode

- ⇒ Close the cover
- ⇒ Turn the machine OFF. Wait for a minimum of 1 second.
- ⇒ Turn the machine ON. The toaster will start in warm up mode as usual.

SPECIFICATIONS

Model	Voltage	Power	Current	Toast Output	Nominal Dimensions		
					Width	Height	Depth
ST350A	230VAC	2300W	10A	Up to 350 slices per hour	410mm	420mm (closed)	600mm (closed)
ST500A	230VAC	2990W	13A	Up to 500 slices per hour		680mm (open)	640mm (open)

NOTE: Constant Research and Development may necessitate machine changes at any time.

APPENDIX A

RESIDUAL CURRENT DEVICES (RCD'S)

Also known as Earth Leakage Protection systems, an RCD is a protective device that automatically disconnects the active conductors of a circuit when an earth leakage current reaches a predetermined value.

Although RCD's are mandatory in domestic installations, and in the final sub-circuits of residential-type areas, the Australian Standards quote that the requirement of an RCD does "not apply to a socket-outlet.....for the connection of fixed electric cooking appliances, such as ranges, ovens or hotplates"

In installations that are neither Domestic nor Residential-type, AS/NZS 3000 2.5.3.3 states that RCD's are needed only in situations where equipment may represent an increased risk of electric shock to the user, and there are many special comments related to the use of heating elements.

AS/NZS3000 2.5.2 gives the following warnings that should have been taken into consideration when an RCD circuit was installed.

To avoid unwanted tripping due to leakage currents and transient disturbances, care should be taken to ensure that the sum of the leakage currents of electrical equipment on the load side of an RCD is less than 1/3 of its rated residual current.

To avoid excessive leakage current causing unwanted tripping where socket-outlets are protected by one RCD having a rated residual current not greater than 30mA, consideration should be given to the number of socket-outlets protected and the nature of electrical equipment likely to be connected to the socket-outlets.

Tubular elements (such as those used in this unit) reaching temperatures greater than 110°C are subject to moisture absorption and therefore earth leakage current generation. Should the installation and use of this unit trip an RCD the unit will need to be run on a circuit without an RCD (as mentioned above) for approximately 30-60 minutes, after which time the elements should have dried out and the machine should function normally. If you are unable to locate a circuit without an RCD please contact your supplier, or if you prefer you can contact Roband and send the unit to one of our offices where we can run the machine on a suitable circuit free of charge (a return freight charge may apply).

Declaration of Conformity

We the undersigned,

Manufacturer	Roband Australia Pty Ltd
Address	1 Inman Road Cromer NSW 2099
Country	Australia
Authorised Representative in EU	Metcalfe Catering
Address	Haygarth Park, Blaenau Ffestiniog Gwynedd North Wales
Country	United Kingdom

Certify and declare under our sole responsibility the following equipment,

ST500A, ST350A, ST500M, ST350M

Conforms with the requirements of the following EU Directives,

EMC Directive 2004/108/EC
Low Voltage Directive 2006/95/EC
RoHS Directive 2011/65/EU
Machinery Directive, 2006/42/EC

Based upon the following specifications applied

EN55014.2:1997 Electromagnetic Compatibility. Requirements for household appliances, electric tools and similar apparatus. Immunity.
EN60335.1:2012 Household and similar electrical appliances - Safety.
EN60335.2.48:2008 Household and similar electrical appliances – Safety – Particular requirements for commercial electric grillers and toasters.

Signed:

Printed Name

Position in organisation



Shane Marshall

Engineering Manager

Roband Australia Pty Ltd

Date:

1st April 2016

WARRANTY

Every care is taken to ensure that no defective equipment leaves our factory and all goods manufactured by us are guaranteed against defective workmanship and materials for a period of 12 months from the date of purchase. Roband Australia's obligations pursuant to this express warranty being limited to the repair or replacement of the defective goods or materials, at its option and subject to the terms contained within this Warranty statement. Where relevant, glass, Teflon® and lamps are **not** included in this warranty and RCD tripping due to moisture absorption by Tubular Heating Elements is not considered a warranty fault.

Generally, all goods claimed under this warranty must be returned to the factory or an authorized service agent, freight prepaid, for inspection. All parts deemed to be defective will be replaced, however, no claims will be entertained for second hand products, or parts damaged in transport, misused or modified in any way without our approval. For machines that are not considered to be portable (e.g. food bars, rotisseries, large hotplates and some bain maries), on site warranty service will be provided in capital city metropolitan areas only. In all other locations, the customer is responsible for all travelling time/service call costs and payment for this will be required prior to the commencement of the repair. The labour costs to actually repair the fault will be met by the company.

Any repairs or replacement of defective goods or materials pursuant to this warranty, must be authorized by Roband Australia prior to any action being taken. The company reserves the right to reject a claim for warranty if it is not completely satisfied with the circumstances under which it occurred and any other costs incurred for false claims or faults due to incorrect usage etc. are the responsibility of the claimant. Roband Australia Pty Ltd nor any subsidiary company or Agent shall be liable for loss of profit or damage to other equipment and property except where it is in breach of the guarantees provided in accordance with Schedule 2 of the Competition and Consumer Act 2010 (Cth) or the applicable legislation from time to time.

The goods come with guarantees that cannot be excluded under the Australian Consumer Law (ACL). You are entitled to a replacement or refund for a major failure and for compensation for any other reasonably foreseeable loss or damage. You are also entitled to have the goods repaired or replaced if they fail to be of acceptable quality and the failure does not constitute a major failure.

Generally, authorized service agents are located in all areas which have authorized distribution dealers. For the name of your nearest Australian authorised service agent, please contact:

Roband Australia Pty Ltd

1 Inman Road, Cromer, NSW 2099

Warranty Number: 1800 268 848

Phone: (02) 9971 1788 Fax: (02) 9971 1336

All other countries please contact your selling Agent.

Please complete the following details and keep this card in a safe place.

NAME _____

ADDRESS _____

MODEL No: _____ SERIAL No: _____ DATE PURCHASE _____

NAME OF DEALER: _____

PLEASE RETAIN THIS SECTION FOR YOUR RECORDS

DO NOT POST

ROBAND® AUSTRALIA PTY LTD

OTHER LEADING PRODUCTS AVAILABLE:

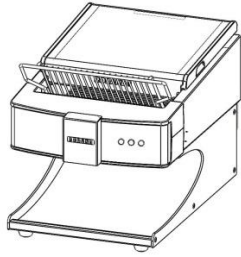

Sycloid Toaster



DRINK MIXERS

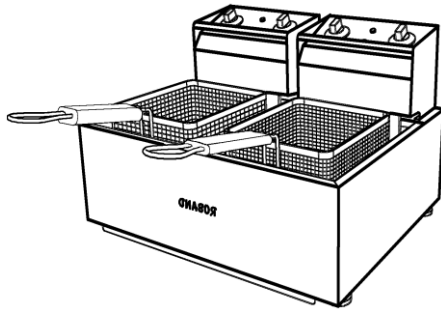

HIGH PERFORMANCE DEEP FRYERS

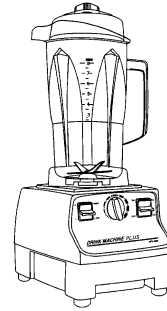

VITAMIX BLENDERS

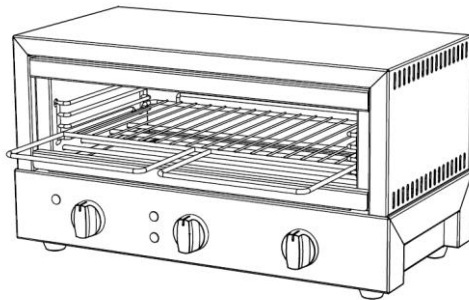

GRILLMAX TOASTERS

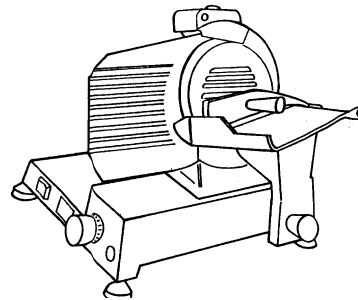

NOAW Slicers

Manufactured/Imported in Australia by:

ROBAND[®]
AUSTRALIA PTY LTD

Authorised Distributor/Agent