



Waldorf®

800 SERIES

Installation and Operation Manual

HPO Fast-Fri Gas Fryer

FN8130GHPO
FNL8130GHPO



Date Purchased

Serial Number

Dealer

Service Provider

MANUFACTURED BY

Moffat Limited

Christchurch
New Zealand

INTERNATIONAL CONTACTS

AUSTRALIA

Moffat Pty Limited

E.Mail: vsales@moffat.com.au
Main Office: (tel): +61 (03) 9518 3888
(fax): +61 (03) 9518 3833
Service: (tel): 1800 622 216
Spares: (tel): 1800 337 963
Customer Service: (tel): 1800 335 315
(fax): 1800 350 281

CANADA

Serve Canada

Web: www.servecanada.com
E.Mail: info@servecanada.com
Sales: (tel): 800 551 8795 (Toll Free)
Service: (tel): 800 263 1455 (Toll Free)

NEW ZEALAND

Moffat Limited

Web: www.moffat.co.nz
E.Mail: sales@moffat.co.nz
Main Office: (tel): 0800 663328

UNITED KINGDOM

Blue Seal

Web: www.blue-seal.co.uk
E.Mail: sales@blue-seal.co.uk
Sales: (tel): +44 121 327 5575
(fax): +44 121 327 9711
Spares: (tel): +44 121 322 6640
(fax): +44 121 327 9201
Service: (tel): +44 121 322 6644
(fax): +44 121 327 6257

UNITED STATES

Moffat

Web: www.moffat.com
Sales: (tel): 800 551 8795 (Toll Free)
(tel): +1 336 661 1556
(fax): +1 336 661 9546
Service: (tel): 800 858 4477 (Toll Free)
(tel): +1 366 661 1556
(fax): +1 336 661 1660

REST OF WORLD

Moffat Limited

Web: www.moffat.co.nz
E.Mail: export@moffat.co.nz

The reproduction or copying of any part of this manual by any means whatsoever is strictly forbidden unless authorized previously in writing by the manufacturer.

In line with policy to continually develop and improve its products, Moffat Ltd. reserves the right to change the specifications and design without prior notice.

Waldorf GHPO Gas Fryer**FN(L)8130GHPO 'FAST-FRI' GAS FRYER (Single Tank - 31 ltr)**

Introduction	2
Specifications	3
Model Numbers Covered in this Specification	
Gas Supply Requirements	
Electrical Supply Requirements	
Dimensions.....	4
Installation.....	5
Installation Requirements	
Unpacking	
Location	
Clearances	
Assembly	
Electrical Connection	
Fitting Rear Rollers	
Gas Connection	
Commissioning	
Operation	10
Operation Guide	
Description of Controls	
Filling the Tank	
Lighting Main Burners	
Setting Operating Temperature	
Turning 'OFF' the Fryer	
Cleaning and Maintenance.....	13
General	
Draining and Daily Cleaning	
Weekly Cleaning	
Periodic Maintenance	
Fault Finding	16
Guide to Cooking Problems with Fryer	
Fault Finding the Gas System - Fault Finding Table	
Circuit Schematic	19
Gas Conversion and Specifications.....	20
Conversion Procedure	
Gas Specifications	
Replacement Parts List	22

Introduction

We are confident that you will be delighted with your Waldorf HPO Fast-Fri Gas Fryer and it will become a most valued appliance in your commercial kitchen.

To ensure you receive the utmost benefit from your new appliance, there are two important things you can do.

Firstly

Please read the instruction book carefully and follow the directions given. The time taken will be well spent.

Secondly

If you are unsure of any aspect of the installation, instructions or performance of your appliance, contact you WALDORF dealer promptly. In many cases, a phone call could answer your questions.



Warning

IMPROPER INSTALLATION, ADJUSTMENT, ALTERATION, SERVICE OR MAINTENANCE CAN CAUSE PROPERTY DAMAGE, INJURY OR DEATH. READ THE INSTALLATION, OPERATING AND MAINTENANCE INSTRUCTIONS THOROUGHLY BEFORE INSTALLING OR SERVICING THIS APPLIANCE.



Warning

INSTRUCTIONS TO BE FOLLOWED IN THE EVENT THE USER SMELLS GAS ARE TO BE POSTED IN A PROMINENT LOCATION. THIS INFORMATION SHALL BE OBTAINED BY CONSULTING THE LOCAL GAS SUPPLIER.



Warning

GREAT CARE MUST BE TAKEN BY THE OPERATOR TO USE THE EQUIPMENT SAFELY TO GUARD IT AGAINST RISK OF FIRE.

- **THE APPLIANCE MUST NOT BE LEFT ON UNATTENDED.**
 - **IT IS RECOMMENDED THAT A REGULAR INSPECTION IS MADE BY A COMPETENT SERVICE PERSON TO ENSURE CORRECT AND SAFE OPERATION OF YOUR APPLIANCE IS MAINTAINED.**
 - **DO NOT STORE OR USE GASOLINE OR OTHER FLAMMABLE VAPOURS OR LIQUIDS IN THE VICINITY OF THIS OR ANY OTHER APPLIANCE.**
 - **DO NOT SPRAY AEROSOLS IN THE VICINITY OF THIS APPLIANCE WHILE IT IS IN OPERATION.**
-



Caution

- **This appliance is for professional use and is only to be used by qualified persons.**
 - **Only authorised service persons are to carry out installation, servicing or gas conversion operations.**
 - **Components having adjustments protected (e.g. paint sealed) by the manufacturer should not be adjusted by the user / operator.**
 - **DO NOT operate the appliance without the legs supplied fitted.**
-

Model Numbers Covered in this Specification

FN[1]8130GHPO 'FAST FRI' GAS FRYER (Single Tank - 31 ltr).

NOTE:

[1] - Back Options;

- Standard Models.
- L - Low Back Models.

Gas Supply Requirements

	Natural Gas	LP Gas (Propane)
Input Rating (N.H.G.C.)	140 MJ/hr (133,000 Btu/hr)	140 MJ/hr (133,000 Btu/hr)
Operating Pressure	1.13 - 3.40 kPa (4.5" - 13.5" w.c.)	2.75 - 3.40 kPa (11" - 13.5" w.c.)
Burner Pressure	0.87 kPa (*) (3.4" w.c.)	2.55 kPa (*) (10.2" w.c.)
Gas Connection	3/4" BSP Male	

NOTE:

(*) Measure burner operating pressure at Operating Pressure Test Point (Lower - Out) on gas control valve with both burners operating at the 'High Flame' setting. Refer to 'Gas Conversion and Specification' Section for further details.

Electrical Supply Requirements

FN8130GHPO - 220-240 V a.c, 50 Hz, 0.5A, 1P+N+E.

3 pin 10A cord set fitted.

Dimensions

Dimensions: FN(L)8130GHPO

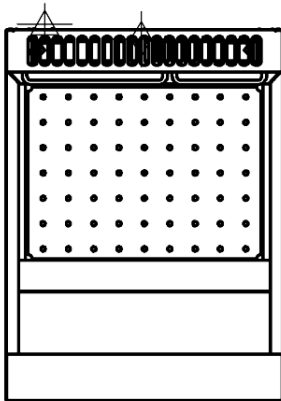
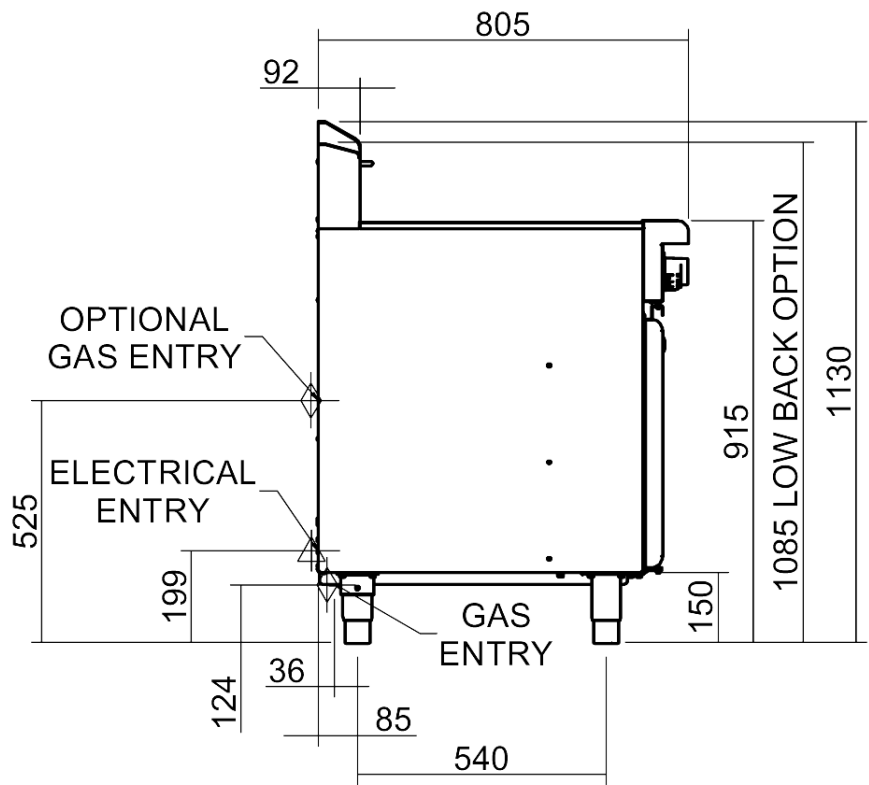
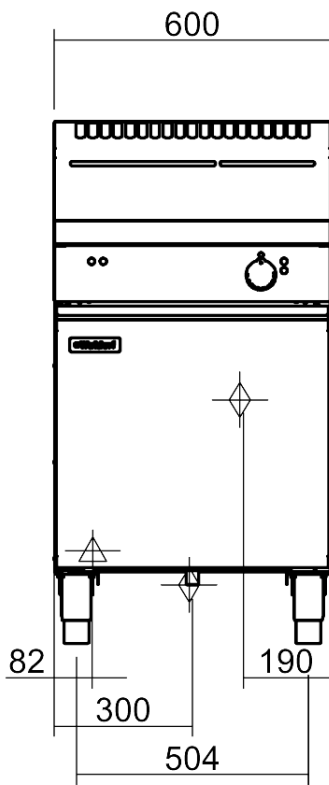

Installation Requirements

NOTE:

- **It is most important that this appliance is installed correctly and that operation is correct before use. Installation shall comply with local gas, electrical and health and safety requirements.**
- **This appliance shall be installed with sufficient ventilation to prevent the occurrence of unacceptable concentrations of health harmful substances in the room, appliance is installed in.**

Waldorf 'FAST-FRI' HPO Fryers are designed to provide years of satisfactory service, and correct installation is essential to achieve the best performance, efficiency and trouble-free operation.

This appliance must be installed in accordance with National installation codes and in addition, in accordance with relevant National / Local codes covering gas, electrical, fire and health and safety.

Australia / New Zealand: - AS5601.1 - Gas Installations.

Australia / New Zealand: - AS / NZS3000 - Wiring Rules.

Installation must be carried out by authorised persons only. Failure to install equipment to relevant codes and manufacturers specifications shown in this section will void the warranty.

Components having adjustments protected (e.g. paint sealed) by manufacturer are only to be adjusted by an authorised service agent. They are not to be adjusted by the installation person.

Unpacking

- Remove all packaging and transit protection from appliance, including all protective plastic coating from door, outer panels and exterior stainless steel panels.
- Check equipment and parts for damage. Report any damage immediately to carrier and distributor.
- Report any deficiencies to distributor who supplied appliance.
- Check available gas supply is correct to as shown on rating plate located behind access door.
- Check the following parts have been supplied with the appliance:-

FN8130GHPO

Baskets	2
Basket Grids	1
Lid	1
Drain Stick	1
Drain Extension	1

Location

1. This appliance must be installed in a suitably ventilated room to prevent dangerous build up of combustion products.
2. Installation must allow for a sufficient flow of fresh air for combustion air supply. Combustion air requirements:-

Combustion Air Requirements

All Gas Types 24 m³/hr minimum.

3. Never directly connect a ventilation system to the appliance flue outlet.
4. A minimum of 610mm clearance must be maintained from flue outlet to any above surface.
5. Position appliance in its approximate working position.
6. All air for burner combustion is supplied from beneath the unit. Legs must always be fitted and no obstructions placed beneath or around base of fryer, as obstructions will cause incorrect operation and / or failure of the fryer.

NOTE: Do not obstruct or block the appliance flue. Never directly connect a ventilation system to the appliance flue outlet.

Installation

Clearances

NOTE:

- **Only non-combustible materials can be used in close proximity to this appliance.**
- **To allow easy operation, drainage and servicing of appliance, a minimum of 600mm clearance should be maintained at front of appliance.**

Any gas burning appliance requires adequate clearance and ventilation for optimum and trouble-free operation. The following minimum installation clearances are to be adhered to:

	Combustible Surface	Non Combustible Surface
Left / Right Hand Side	50mm	0mm
Rear	50mm	0mm

Assembly

This model is delivered completely assembled. Ensure that the legs are securely attached.

NOTE:

- **This appliance is fitted with adjustable feet so that the appliance can be positioned securely and level. This should be carried out on completion of gas connection. Refer to 'Gas Connection Section'.**
- **This appliance can also be fitted with rear rollers to enable it to be easily moved for positioning and cleaning. If desired, these rollers are supplied in the packaging, with the appliance. See overleaf for fitting instructions.**

Electrical Connection

NOTE: ALL ELECTRICAL CONNECTIONS MUST ONLY BE CARRIED OUT BY AN AUTHORISED PERSON.

Each fryer should be connected to an adequately protected power supply and isolation switch mounted adjacent to, but not behind fryer. This switch must be clearly marked and readily accessible in case of fire.

NOTE:

- **This appliance must be grounded / earthed.**

Fitting Rear Rollers.

1. Raise appliance from the floor by approx. 75mm using suitable lifting equipment (i.e. Palletiser / Forklift) to allow rear adjustable feet to be removed.
2. Unscrew and remove both rear adjustable feet from rear leg housings.
3. Fit rear roller to rear leg housing and align screw hole in side of rear leg housing with threaded hole in rear roller.
4. Secure rear roller to leg support with bolt supplied and tighten bolt.
5. Fit second roller and tighten.
6. Lower appliance back to floor and adjust front adjustable feet to level appliance.

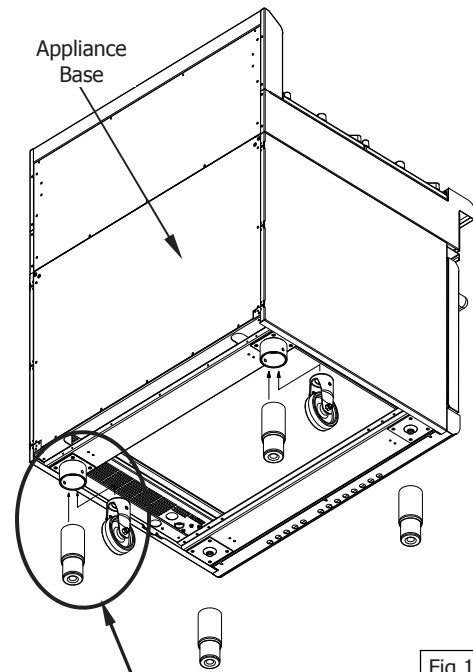
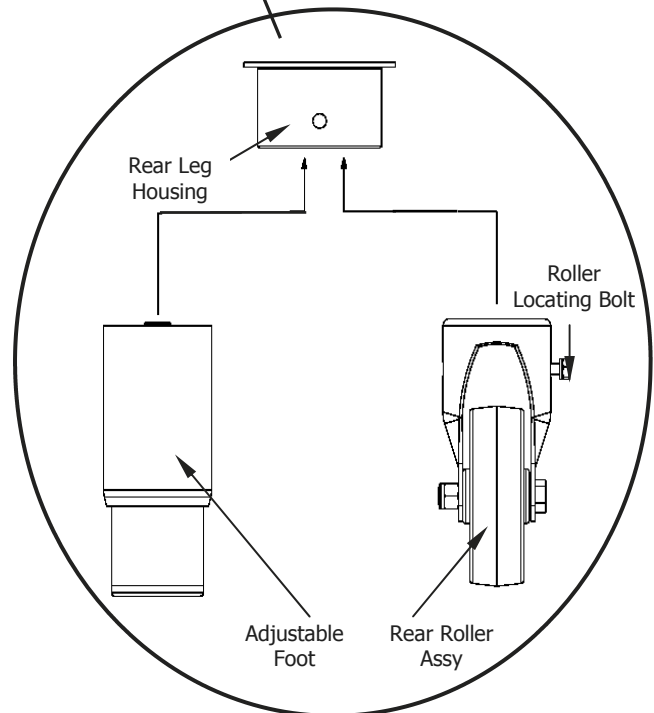

Fig 1



Installation

Gas Connection

NOTE: ALL GAS FITTING MUST ONLY BE CARRIED OUT BY AN AUTHORISED PERSON.

- Flexible Hose Connection

If a Gas Hose assembly is used to connect this appliance, hose and all fittings must have a minimum 3/4" (Natural Gas) or 1/2" (LPG) inside bore diameter to ensure gas flow rate capacity required by this appliance is achieved.

This must be verified by operating pressure testing at maximum gas supply demand condition.

The Gas Hose assembly should also be classified for use in commercial kitchen conditions, appliance will be used in.

Recommended Gas Hose Assembly Specification:

- AS/NZS 1869 Class B or D compliant or equivalent, that meets the following requirements:-

Class	Max Working Pressure at 23 ± 2°C	Working Temperature Range	Resistance to Oil
B	7.0 kPa	- 20°C to + 125°C	Oil resistant lining and cover.
D	2.6 MPa		

1. It is essential that the gas supply is correct for appliance being installed and that adequate supply pressure and volume are available. Carry out the following checks before installation:-

- Gas Type** the appliance has been supplied for is shown on coloured stickers located above the gas connection point and next to the rating plate. Check that this is correct for gas supply the appliance is being installed for. Gas conversion procedure is shown in this manual.
- Supply Pressure** required for this appliance is shown in 'Specifications' section of this manual. Check gas supply to ensure adequate supply pressure exists.
- Input Rate** of this appliance is shown on Rating Plate fitted to inside of access door and in 'Specifications' section of this manual. Input rate should be checked against available gas supply line capacity. **Particular note should be taken if appliance is being added to an existing installation.**



NOTE: It is important that adequately sized piping runs directly to connection joint on the appliance, with as few tees and elbows as possible to give maximum supply volume.

2. A suitable joining compound which resists the breakdown action of LPG must be used on every gas line connection, unless compression fittings are used.

Connection to appliance is 3/4" BSP male.

NOTE: A Manual Isolation Valve must be fitted to the individual appliance supply line.

- Correctly locate the appliance into its final operating position, using a spirit level, adjust legs so that unit is level and at the correct height.
- Connect gas supply to appliance.
- Check all gas connections for leakage using soapy water or other gas detecting equipment.



Warning

DO NOT USE A NAKED FLAME TO CHECK FOR GAS LEAKAGES.

6. Check gas supply pressure is as shown in **Specifications** section, **Gas Supply Requirements** table.

NOTE: Measure supply pressure at Upper Test Point (Supply Pressure) on gas control valve.



Caution

Ensure the fryer tank(s) is / are filled with either water or oil prior to starting Main Burners otherwise damage may be caused to tank(s).

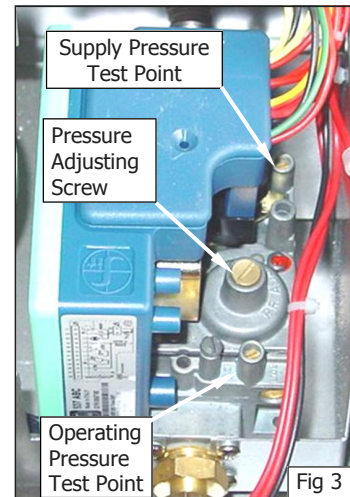

7. Light Main Burners. Refer to 'Operation' section, 'Lighting the Main Burners'.
8. Verify that the supply pressure is still correct.
9. Check Main Burner operating pressure (Adjust, using 'Operating Pressure Adjusting Screw' on gas control valve, see Fig 3), and as shown in 'Gas Conversion and Specifications' section, 'Main Burner Operating Pressure Adjustment'.

NOTE: Insufficient gas supply line capacity, indicated by supply pressure drop during maximum gas supply demand, is NOT ACCEPTABLE and may invalidate manufacturers warranty for this appliance.

Commissioning

Carry out the following commissioning checks before handing over the fryer for use, to ensure that the fryer operates correctly and operator(s) understand correct operating procedure.

1. Before leaving the new installation;
 - a. Check the following functions in accordance with operating instructions shown in 'Operation' section of this manual.
 - Light the Main Burners.
 - Check the Thermostat Operation (refer to 'Operation' section of this manual).
 - b. Thermostat operation check should be carried out by filling the fryer with oil / shortening to the oil 'FILL LEVEL' mark at rear of the tank and setting the thermostat to 180°C. Turn **ON** main burners as shown in 'Operation Instructions' in this manual.
 - c. Once oil is up to temperature, check thermostat calibration. If a discrepancy is found, thermostat calibration should be referred to the supplier.
 - d. Ensure each operator has been instructed in areas of correct lighting, operation, and shutdown procedures for this appliance.

Initial Start-Up

Before using the fryer;

- a. For first time use of the fryer, prior to using for cooking product, fill the fryer with oil and operate for about 1 hour at 'Full Flame' setting to remove any fumes or odours which may be present from the new appliance.
 - b. Refer to the Operation Section of this manual for details on how to operate the fryer.
2. This manual must be kept by the owner for future reference and a record of **Date of Purchase**, **Date of Installation** and **Serial Number of Unit** recorded and kept with this manual. **(These details can be found on Rating Plate attached to rear of access door. Refer to Figure 2).**

NOTE: If it is not possible to get appliance to operate correctly, shut off gas supply and contact the supplier of this unit.

Operation

Operation Guide



Warning

GREAT CARE MUST BE TAKEN BY OPERATOR, TO USE THE FRYER SAFELY, TO GUARD AGAINST RISK OF INJURY AND FIRE.

- **DO NOT LEAVE FRYER UN-ATTENDED DURING OPERATION.**
- **DO NOT REPLENISH THE OIL (FRYING MEDIUM) IN THE FRYER WHEN THE FRYER IS HOT.**
- **DO NOT OVER FILL THE OIL (FRYING MEDIUM) IN THE FRYER ABOVE THE TOP LEVEL MARK.**
- **DO NOT ALLOW THE OIL (FRYING MEDIUM) IN THE FRYER TO FALL BELOW THE LOWER LEVEL MARK.**
- **DO NOT ALLOW THE OIL (FRYING MEDIUM) IN THE FRYER TO OVERHEAT.**
- **DO NOT INTRODUCE WET FOOD OR WATER INTO THE HOT OIL (FRYING MEDIUM).**
- **DO NOT USE FLAMMIBLE SOLVENTS AND CLEANING AIDS ON OR IN CLOSE PROXIMITY TO THE FRYER WHILST THE FRYER IS STILL HOT.**



Caution

- **This appliance is for professional use and is only to be used by qualified persons.**
- **Only authorised service persons are to carry out installation, servicing or gas conversion operations.**
- **Components having adjustments protected (e.g. paint sealed) by the manufacturer should not be adjusted by the user / operator.**

Description of Controls

FN8130GHPO (Access Door Shown Removed)

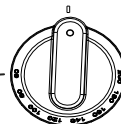
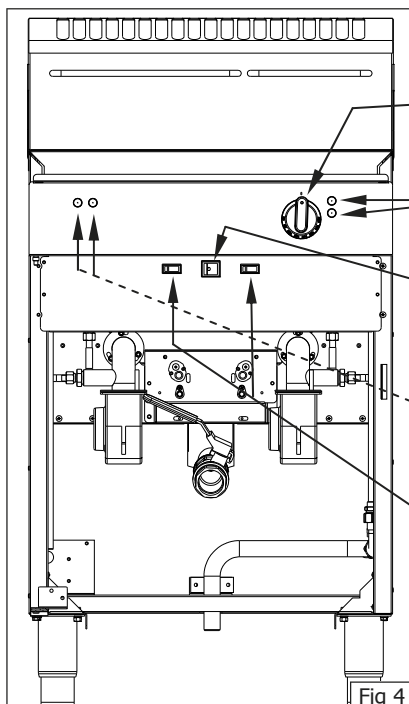

Thermostat Control Knob

Temperature Graduations
95°C to 195°C.

Heating 'ON' Indicator.
(Indicates when burners are cycling On to maintain set temperature).

Main Power Switch

Turns power 'ON' and 'OFF' to the unit. (Red LED Indicator illuminates when switched 'ON').

Lock Out Indicators
(Red)

Left and Right Lock Out Reset Indicators.

Located Behind Main Access Door

Left and Right Burner Reset Switches

Operating these switches resets the burner selected. (Press and release to operate).

Filling the Tank



Warning

DANGER OF FIRE EXISTS IF OIL LEVEL IS BELOW THE MINIMUM 'LO' INDICATED LEVEL

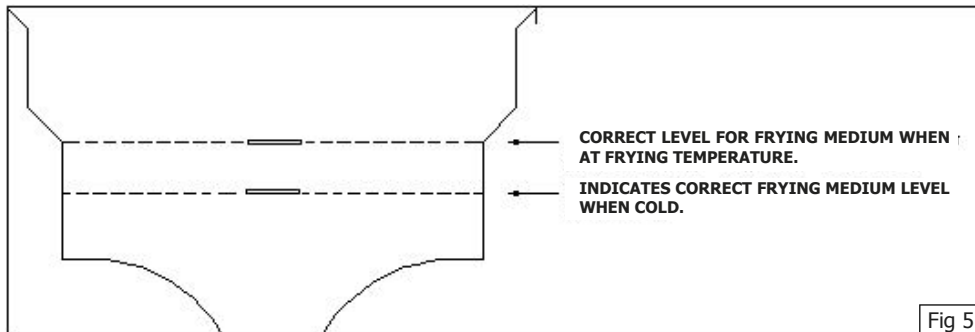

NOTE: WALDORF 'FAST-FRI HPO' fryers can be used with both oil and shortening.

1. Before filling the tank, always check that the drain valve, located behind the access door, is closed. A locking slide is provided on the valve and this should always be locked in position during use.

OIL - Carefully fill the fryer tank with oil to the lower 'Fill Level' mark shown at the rear of the tank. Set the thermostat to the required operating temperature, the oil will expand as heated and will reach the upper level mark when the oil is hot (180-190°C).

- GT60HPO fryer will hold 31 litres of oil.

SHORTENING - Ideally shortening should be pre-melted prior to putting it into the tank. This is normally done in a suitable vessel on a boiling table burner. The liquefied shortening can then be poured into the tank until it reaches the 'FILL LEVEL' mark.

- GT60HPO fryer will hold 46.5 lbs shortening.

Pre-Heating

NOTE: When pre-melting shortening, only heat until the shortening is just liquefied. Do not bring shortening up to high temperature as handling of hot shortening is dangerous.

- If pre-melting of shortening is not possible, carefully cut the shortening in to small pieces and pack into the tank
- Light main burners and manually cycle burners **On/Off** until shortening has liquefied. Ideally main burners should be cycled **On** for 5 seconds and **Off** for 10 seconds. Repeat the cycle until all the shortening is melted. Following this procedure should allow shortening to liquefy gradually without scorching. Once shortening has liquefied, it can be brought up to fryer operating temperature.
- To speed up this process, break up the shortening and stir carefully during the melting process. Add more shortening until the tank is filled to the level marked on the tank side. Refer to Fig 5 above.

NOTE: Running burners continuously will cause shortening in contact with the tank to overheat, resulting in premature oil breakdown. Never allow shortening to smoke while melting as this indicates that the temperature is too high. If shortening starts smoking, increase main burner 'Off' intervals.

Operation

Lighting Main Burners

1. Turn 'ON' fryer main power switch, located in the centre of lower control panel. Main power switch will illuminate (Red) and green (Power On) neon on right hand side of upper control panel will illuminate.
2. Check the 2 (Red) lock out indicator Led's on left hand side of control panel are not illuminated. If any of the lock out indicators are illuminated, press left or right hand burner reset switches on either side of the main power switch, to reset the control system for that side burner.
3. Set thermostat knob to required frying temperature.
4. The 'Orange' heating indicator on the RH Side of the top control panel will illuminate when burners are On and will go out when oil is at pre-set temperature.
5. If left or right 'Red 'Lock Out' indicators illuminate, press left or right burner reset switches on either side of the main power switch, to reset control system for that burner.

Setting Operating Temperature

1. The temperature used for frying food is the most important aspect of fryer operation. Incorrect temperatures will result in poor product quality and will reduce life of oil / shortening.
2. Temperature can be set from 95°C to 195°C, we do not recommend food be cooked above 190°C.
3. Main burners will operate automatically to maintain this temperature.
4. As a safety precaution all Waldorf 'Vee-Ray' fryers feature an Over-Heat control which will turn Off the fryer in the event that the oil reaches over 220°C, should there be a thermostat failure.
5. If a fault occurs or the fryer is not functioning correctly, contact your local service agent.

Turning 'OFF' the Fryer



Turning OFF thermostat does not turn OFF main power to fryer. Power should ALWAYS be turned OFF at main power switch located behind access door.

1. Turn 'OFF' the main power switch located on the fryer front control panel, the red indicator on the 'ON' - 'OFF' main power switch and the green neon on the right of the upper control panel will extinguish. Close the main access door.
2. Check that the two 'Red' neon Lockout indicators located on the front control panel are extinguished.
3. The thermostat control knob can be left at the normal operating temperature for future use.

IMPORTANT:

Should any abnormal operation like;

- ignition problems,
- abnormal burner flame,
- burner control problems,
- partial or full loss of burner flame in normal operation,

If any of the above problems are noticed, the appliance requires IMMEDIATE service by a qualified service person and should not be used until a service is carried out.

Cleaning and Maintenance

General



Warning

DO NOT USE FLAMMIBLE SOLVENTS AND CLEANING AIDS ON OR IN CLOSE PROXIMITY TO FRYER WHILST FRYER IS STILL HOT.



Caution

Always turn 'Off' gas supply before cleaning.

This appliance is not water proof.

Do not use water jet spray to clean interior or exterior of this appliance.

- To achieve the best results, cleaning must be regular and thorough and all controls and mechanical parts checked and adjusted periodically by a competent serviceman. If any small faults occur, have them attended to promptly.
- Don't wait until they cause a complete breakdown. It is recommended that the appliance is serviced every 6 months.
- Clean the fryer regularly. A clean fryer looks better, will last longer and will perform better.

NOTE:

- **DO NOT use abrasive detergents, sharp scrapers, strong solvents or caustic detergents as they could corrode or damage the fryer.**
- **Ensure that any detergent or cleaning material has been completely removed after each cleaning.**

To keep your fryer clean and operating at peak efficiency, follow the procedures below:-

Draining and Daily Cleaning

1. At end of each day or at the end of each shift, if frying schedule is heavy, frying medium should be drained and filtered into a receptacle.



Warning

DO NOT ATTEMPT TO MOVE FRYER WHILST FRYER IS FULL OF OIL.

BEFORE ATTEMPTING TO MOVE FRYER, ENSURE THAT ALL THE OIL HAS BEEN DRAINED FROM THE TANK. REFER TO INFORMATION ON PREVIOUS PAGE, ON HOW TO DRAIN THE OIL FROM THE FRYER.



Caution

**Never drain the fryer with power or burners turned 'ON'
Always switch 'OFF' the fryer before draining or re-filling the tank.**

2. Always filter fryer when cool zone under burners is still hot and liquid. A cold fryer heated up won't drain, because frying medium in this zone will remain hard if using solid fat / oils.
3. Screw drain extension pipe onto end of the drain valve (see Fig 6) and position a suitable container and filter under drain extension pipe.

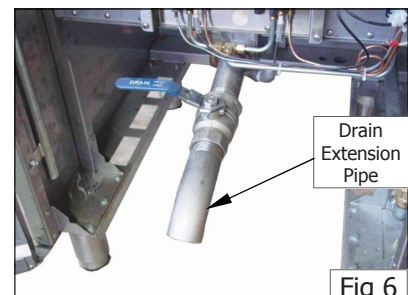

Cleaning and Maintenance

Opening the Drain Valve



Warning

HOT OIL WILL BURN - DO NOT RUSH THIS JOB.

- a. Lift locking slide on valve handle (Fig 7) to release the valve.
- b. While holding locking slide in withdrawn position, rotate handle anticlockwise (Fig 8) to open valve.
- c. When valve is closed, locking slide will drop down over locking valve to prevent accidental opening of the valve (See Fig.7).

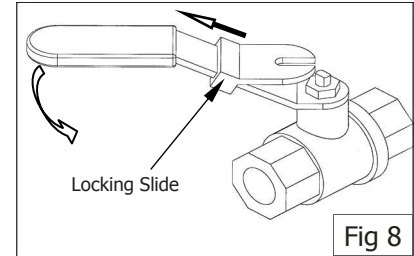
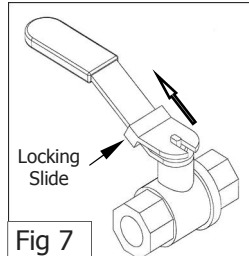

4. Do not empty all of fryer contents into one large container, as this will be dangerous and may be difficult, when lifted up, to pour hot oil back into tank.
5. Slip a muslin or other suitable filter bag over the end of the drain valve. Crumbs will be caught in bag but frying medium will strain freely through into receptacle.
6. Open drain valve slowly to minimise splashing, and take care not to overfill container.
7. If necessary, use the drain stick (see Fig 9) to dislodge any blockages in the drain.
8. When tank has been drained, use a ladle or small pan with a handle and dip into hot frying medium from container and pour around sides and bottom of tank to wash out crumbs and particles adhering to tank.
9. Continue to dip and pour until all crumbs are washed down and into filter bag.
10. Open drain valve fully and check for any particles or crumb residue lodged in valve. Clean out valve with a stiff nylon brush. Do not use a wire brush as this may damage valve seating and will eventually lead to leakage. If obstruction cannot be removed with a brush, use a wooden probe to dislodge the obstruction.
11. Wipe all exterior panels with a cloth dampened with detergent and rinse off any residue with clean warm water.
12. Clean Control Panel with a damp cloth lightly moistened with a solution of water and a commercial quality foodservice approved detergent.
13. Once the daily cleaning operation is completed, close drain valve and pour frying medium back into tank.

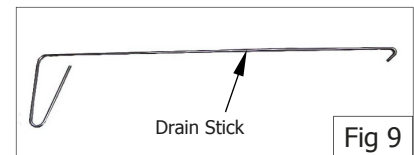

Cleaning and Maintenance

Weekly Cleaning

NOTE: If fryer usage is very high, we recommend the weekly cleaning procedure is carried out more frequently.

1. Proceed to drain and filter the tank as for **Daily Cleaning** . Do not refill tank with frying medium until it has been cleaned as shown below.
2. Fill fryer with cold water to normal fill level and add a high quality commercial cleaner that has been specifically formulated for fryers. *All purpose cleaners are not recommended.*

NOTE: Never use a caustic or lye solution, as this will leave a fat destroying film in the tank.

3. Heat water to approximately 80-90°C.
4. Clean fryer baskets at same time by simply immersing them in cleaning solution. Allow fryer to soak for 5-10 minutes or as directed on cleaner instructions. Remove baskets and turn **OFF** main burners.
5. Scrub the baskets and fryer tank lightly, but vigorously with a stiff nylon bristle brush to remove any remaining deposits. **DO NOT use a wire brush, as this will scratch the tank sides.**
6. Empty fryer and rinse thoroughly with water. Use a 1 part vinegar to 15 parts water solution to rinse tank and neutralise any cleaner residue. If this proves unsuitable for cleaner being used, use a weaker solution of up to 1 part to 25 water.
7. Rinse tank thoroughly with water, drain and dry.
8. Refill tank with new filtered frying medium.

Stainless Steel Surfaces

- a. With fryer tank(s) drained, cleaned and dried as shown above, clean exterior surfaces of fryer with hot water, a mild detergent solution and a soft cloth.
- b. Dry all components thoroughly with a dry cloth and polish with a soft dry cloth.
- c. To remove any discoloration, use an approved stainless steel cleaner or stainless steel wool. Always rub in the direction of the grain.

Periodic Maintenance

NOTE: All maintenance operations should only be carried out by a qualified service person.

To achieve the best results, cleaning must be regular and thorough and all controls and mechanical parts should be checked and adjusted periodically by a qualified service person. If any small faults occur, have them attended to promptly. Don't wait until they cause a complete breakdown.

It is recommended that the appliance is serviced every 6 months.

Fault Finding

Guide to Cooking Problems with Fryer

This section provides an easy reference guide to the more common problems that may occur during the operation of your equipment. The fault finding guide in this section is intended to help you correct, or at least accurately diagnose problems with your equipment.

Although this section covers the most common problems reported, you may encounter a problem not covered in this section. In such instances, please contact your local authorised service agent who will make every effort to help you identify and resolve the problem. Please note that the service agent will require the following information:-

- **Model Code and Serial Number of appliance, which can be found on the Rating Plate located on the inside of the access door.**

Fault	Possible Cause	Remedy
Frying Medium Foaming.	Presence of soap or detergent residue from cleaning the tank.	Rinse fryer thoroughly three times with clean water. Ensure fryer is perfectly dry before re-filling with frying medium.
	Excessive breakdown of frying medium.	Add fresh frying medium daily to replace contents every 3-5 days.
	Continual frying of food with excess moisture.	Remove excess moisture from foods to be fried.
	Continued overheating of oil.	Check thermostat setting. Turn down heat to around 120°C (Standby) when use is quiet.
	Overloading.	Maintain 1-8 ratio of food to frying medium.
Gumming.	Heating frying medium too rapidly.	When charging fryer or starting up, melt frying medium gradually.
	Continued overheating of the frying medium.	Check thermostat setting with a thermometer or thermocouple.
	Frying oil broken down.	Check amount of fresh frying medium added to fryer to be sure 'turnover' is adequate.
	Using wrong cooking frying medium.	Some frying mediums form gums when used in a deep fryer. e.g safflower oil.
Greasy Foods.	Frying at too low temperatures.	Increase temperature and check thermostat setting.
	Inadequate preparation of food.	Be sure foods (especially potatoes) are 'cured' correctly.
	Excessive quantities of breading or batter.	Remove surplus breading or batter.
	Placing food in frying medium direct from the freezer.	Allow frozen foods to thaw before frying.
	Surplus moisture in and on surface of food.	Drain and dry foods before frying.
	Frying medium in advanced stages of breakdown.	Discard 'old' frying medium and refill fryer with new frying medium.
	Use of dripping or other unrefined oil.	Due to low smoking point, cooking in these oils at lower temperatures will result in greater oil absorption by the food.
Using the wrong kind of cooking oil.	Always use a completely refined and deodorised cooking oil.	
Rapid Oil Breakdown.	Inadequate frying oil turnover.	Adjust procedures to fry more food in fryer to increase turnover.
	Overheating of oil.	Check thermostat setting with a thermometer or thermocouple.
	Contamination.	Filter or strain the oil daily.
	Poor cleaning procedures.	Clean fryer daily or at least once a week and rinse thoroughly. Dry fryer before use.
	Presence of copper or brass in the fryer equipment.	Remove all copper or brass fittings from contact with the oil.
	Overloading fryer.	Maintain 1-8 ratio of food to frying oil.
	Food excessively moist.	Drain and dry the food before frying.
	Overheating oil on 'Standby' mode.	Reduce temperature of frying oil between 93°C during idle ('Standby') periods.

Fault Finding

Fault	Possible Cause	Remedy
Oil Smoking.	Insufficient turnover of oil.	Maintain a minimum quantity of oil in fryer for more rapid turnover or increase the quantity of food fried in fryer. Replace with fresh oil every 3 to 5 days.
	Continual frying with excess moisture on food.	Drain foods before frying, pat food dry.
	Contamination of oil.	Filter or strain daily to remove contaminants.
	Overheating of oil.	Check thermostat setting with a thermometer or thermocouple.
	Rapid breakdown of oil.	Use a stable frying oil.
	Use of unrefined oils.	Dripping smokes at lower temperature than refined and deodorised oils.
Darkening of Oil.	Presence of salt on the food.	Salt foods after frying and away from the fryer.
	Foods dipped in batter high in egg yolk.	Reduce egg content of batter, replace part egg with milk.
	Contamination of oil.	Filter or strain oil daily to remove contaminants.
	Poor cleaning practice.	Clean fryer at least weekly or each day in cases of heavy usage. Ensure fryer is perfectly dry before use.
	Overheating of oil.	Check thermostat setting with a thermometer or thermocouple.
	Insufficient oil turnover.	Top up daily to replace the contents of fryer in 3 to 5 days.
	Cooking foods with high sugar levels.	At the end of the season, potatoes are usually high in reduced sugars. When fried, they will darken quickly and colour the oil.

NOTE: Excessive oil usage is an indication of high absorption of oil into the food. This is a function of temperature and character of the goods being fried - NOT due to type of oil being used (unless refined oils are being used). Any variation in the apparent life of the oil is always due to one or more of the causes mentioned above.

Fault Finding

Fault Finding the Gas System - Fault Finding Table

This guide shows the most likely cause of failure should a fault occur. The information provided should enable quick identification of the most probable faults. Should you have problems that are not covered here, please contact your local authorised service agent who will help you identify and resolve the problem. Please note that the service agent will require the following information:-

- **Model Code and Serial Number of appliance. (found on Rating Plate on rear of access door).**

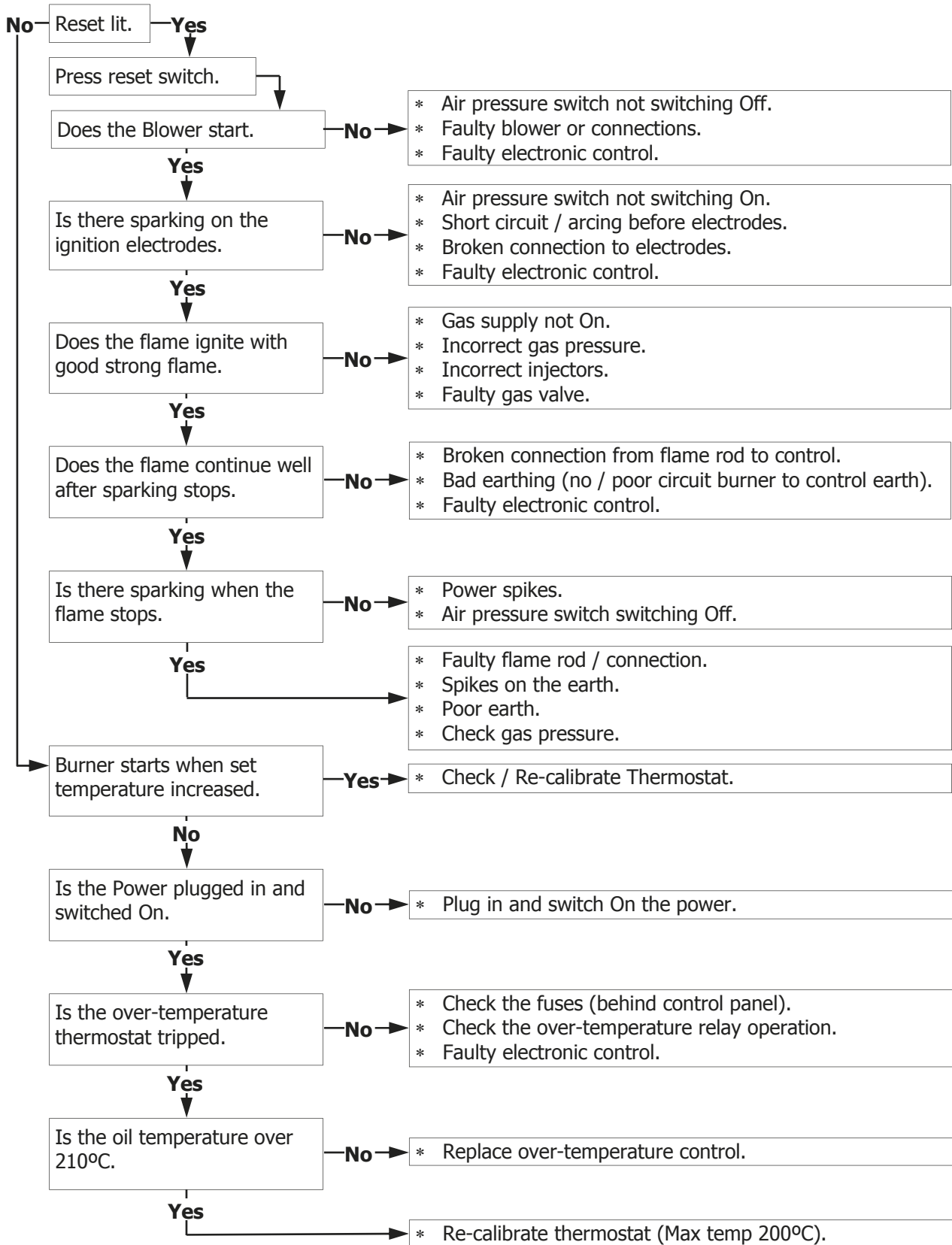

Circuit Wiring Schematic

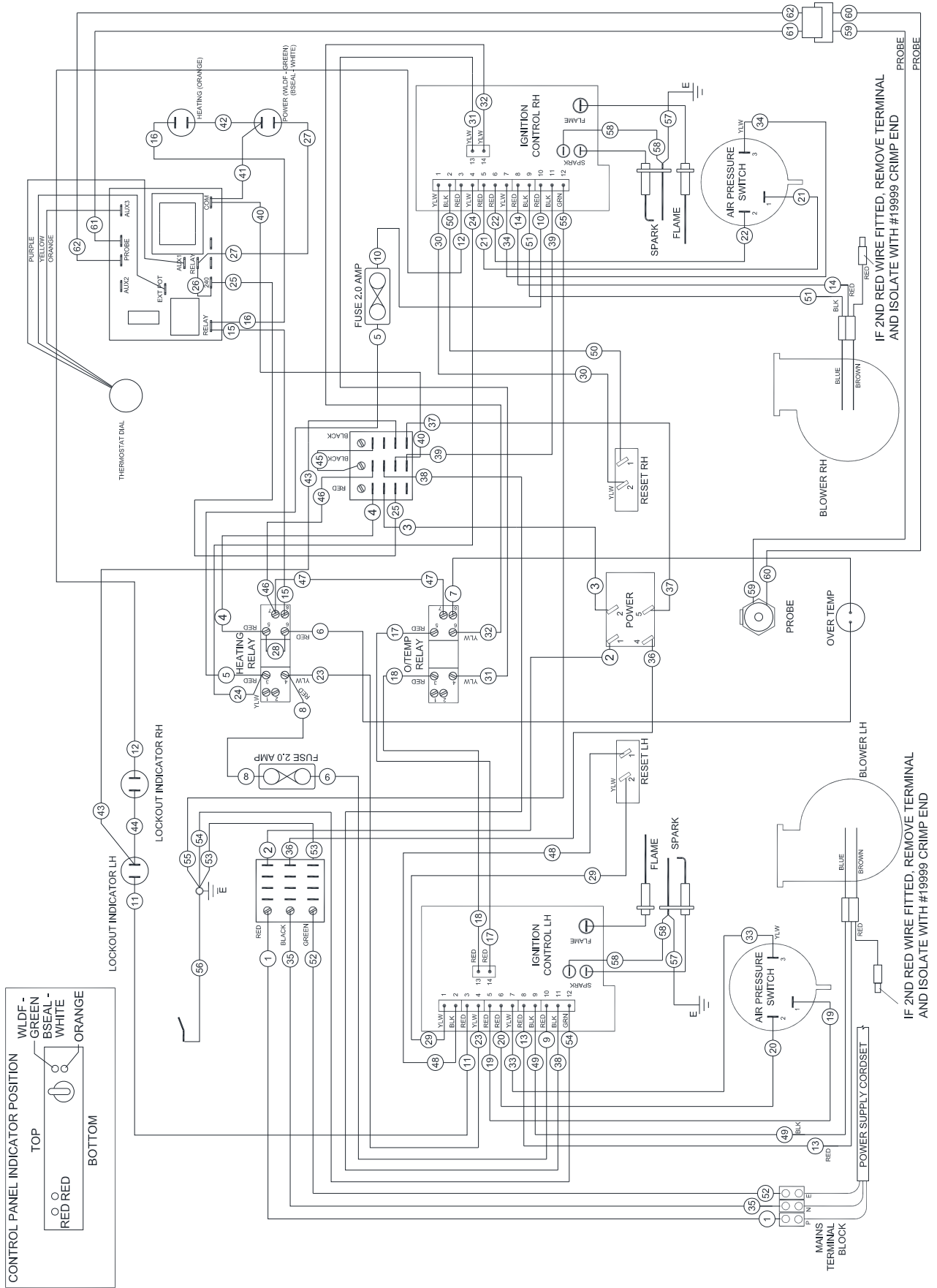

Gas Conversion and Specifications

Conversion Procedure



Caution

Ensure Appliance is isolated from the gas supply before commencing servicing.

NOTE:

- These conversions should only be carried out by qualified persons. All connections must be checked for leaks before re-commissioning the appliance.
- For all relevant gas specifications refer to the table at the rear of this section.

Main Burner Injectors

1. Unscrew the injector gas supply tube fitted into the blower / burner air manifold and air manifold connection.
2. Remove main burner injector connector and injector and replace with correct size injector as shown in 'Gas Specifications Table' at the end of this section.
3. Reconnect the injector gas supply tube.

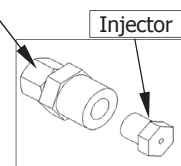
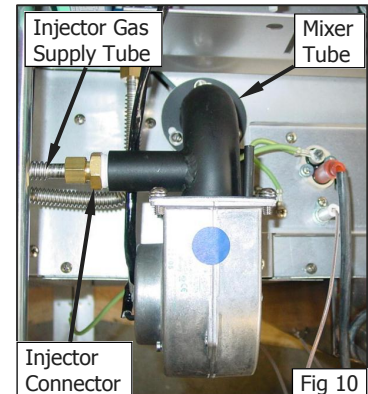

4. Remove 3 screws securing aeration plates to side of blower motors and replace with correct plates. Refer to 'Gas Specifications Table' at end of this section.

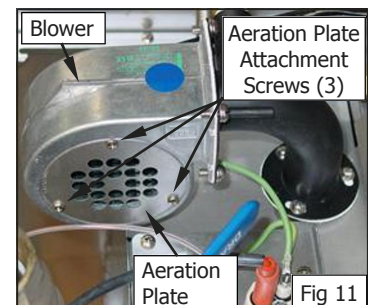

Main Burner Operating Pressure Adjustment

1. Connect a manometer to lower test point (Operating Pressure) on the gas control valve. (Refer to Fig 12).
2. Remove slotted cap to reveal Pressure Adjusting Screw.
3. Turn On gas supply and power supply and light main burners.
4. Adjust regulator pressure adjusting screw to obtain the correct burner pressure for type of gas being used. Refer to 'Gas Specifications Table' at rear of this section.
5. Refit slotted cap to screw adjustment point.

NOTE: Each burner has a separate gas valve / regulator and each must be individually adjusted and set.

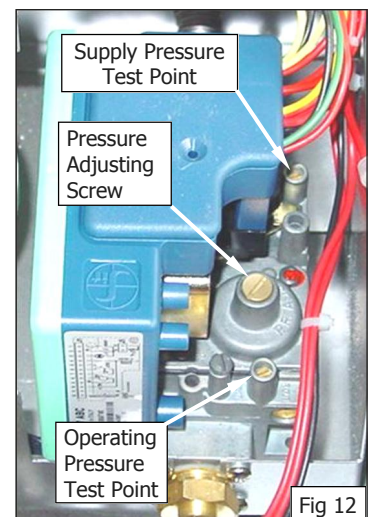

Gas Conversion and Specifications

Gas Type Identification Label

On completion of gas conversion, replace gas type identification label located at:-

- Rear of appliance, above gas connection point.
- Beside rating plate.

Commissioning

Before leaving the converted installation;

1. Check all gas connections for leakage using soapy water or other gas detecting equipment.
2. Check the following functions in accordance with operating instructions specified in 'Operation' section of this manual.
 - Light Main Burners.
 - Check Thermostat operation.
 - Ensure all controls operate correctly.

NOTE: If it is not possible to get the appliance to operate correctly, shut 'Off' gas supply and contact the supplier of this unit.

Gas Specifications

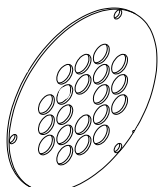
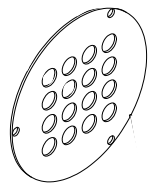
	Natural Gas	LPG
Main Burner Injectors	4.30mm	2.40mm
Aeration Plate	 20 x Ø 9.55 holes	 16 x Ø 9.55 holes
Operating Pressure	0.87 kPa (*) (3.4" w.c.)	2.55 kPa (*) (10.2" w.c.)
Supply Pressure	1.13 - 3.40 kPa (4.5" - 13.5" w.c.)	2.75 - 3.40 kPa (11" - 13.5" w.c.)

NOTE:

- (*) **Measure burner operating pressure at Operating Pressure Test Point (Lower - Out) on gas control valve, this is to be carried out with both burners operating at the 'High Flame' setting.**

Replacement Parts List

Replacement Parts List

IMPORTANT:

Only genuine authorized replacement parts should be used for servicing and repair of this appliance. Instructions supplied with parts should be followed when replacing components.

For further information and servicing instructions, contact your nearest authorized service branch (contact details are as shown on reverse of front cover of this manual).

When ordering replacement parts, please quote part number and description as listed below. If part required is not listed below, request part by description and quote model number and serial number which is shown on the rating plate.

Controls

022594	Gas Control Valve SIT 840.
023163K	Burner Kit.
235357	Thermostat Knob Waldorf 6mm 195 - 100°C.
229685	Temperature Control PC Board.
020117	Thermostat Probe.
018022K	Over-temperature Thermostat.
022593	Electronic Ignition/valve control module.
022596	Pressure Switch.
023160K	Burner Blower Kit.
024792	Ignition Electrode spark.
025383	Ignition Electrode flame.
022663	Fuse 2 Amp.
227963	Heating indicator (Amber).
227962	Power Indicator (Green).
013528	Lock-Out Indicator (Red).
022449	Power Switch.
020258	Reset Switch.
016674	Relay Over-Temp Switching.
016674	Relay Heating Circuit.
016673	Relay Base.

General

023220	Basket.
228578	Basket Tray.
228128	Fish Plate.
227856	Door Magnet.
018358	Drain Valve.
227850	Adjustable Leg (150mm) (Flush Stud).
229674	Rear Roller Assy.
018147	Drain Extension.
018176	Drain Stick.
228898	Splash Guard (Left Hand).
228899	Splash Guard (Right Hand).
228762	Lid Assembly.

Gas Conversion Kits

Models	Gas Type to Convert to	
	Nat. Gas (G20)	LPG (Propane) (G31)
All Models	022696	022695

Accessories

229674 Rear Roller Assy.
228794 600mm (Fryer) Plinth Kit.

