

20MSERIES

turbofan[®]

E20M Series
(Manual Operation)

Installation and Operation Manual

turbofan
CONVECTION OVEN SYSTEMS

MOFFAT[®]

BLUE SEAL[®]

MANUFACTURED BY

Moffat Limited

Christchurch
New Zealand

INTERNATIONAL CONTACTS

AUSTRALIA

Moffat Pty Limited www.moffat.com.au
E.Mail: vsales@moffat.com.au
Main Office: (tel) (03) 9518 3888
(fax) (03) 9518 3833
Service: (tel): 1800 622 216
Spares: (tel): 1800 337 963
Customer Service: (tel): 1800 335 315
(fax): 1800 350 281

CANADA

Serve Canada
Web: www.servecanada.com
E.Mail: info@servecanada.com
Sales: (tel): 800 551 8795 (Toll Free)
Service: (tel): 800 263 1455 (Toll Free)

NEW ZEALAND

Moffat Limited
Web: www.moffat.co.nz
E.Mail: sales@moffat.co.nz
Main Office: (tel): 0800 663328

UNITED KINGDOM

Blue Seal
Web: www.blue-seal.co.uk
E.Mail: sales@blue-seal.co.uk
Sales: (tel): 0121 327 5575
(fax): 0121 327 9711
Spares: (tel): 0121 322 6640
(fax): 0121 327 9201
Service: (tel): 0121 322 6644
(fax): 0121 327 6257

UNITED STATES

Moffat
Web: www.moffat.com
Sales: (tel): 800 551 8795 (Toll Free)
(tel): 336 661 1556
(fax): 336 661 9546
Service: (tel): 800 858 4477 (Toll Free)
(tel): 336 661 1556
(fax): 336 661 1660

REST OF WORLD

Moffat Limited
Web: www.moffat.co.nz
E.Mail: export@moffat.co.nz

The reproduction or copying of any part of this manual by any means whatsoever is strictly forbidden unless authorized previously in writing by the manufacturer.

In line with policy to continually develop and improve its products, Moffat Ltd. reserves the right to change the specifications and design without prior notice.

Contents List

E20M Series Turbofan Convection Ovens.

Model Numbers Covered in this Manual

- E22M3 - Turbofan Oven - 3 Tray Convection Oven.
- E23M3 - Turbofan Oven - 3 Tray Convection Oven.
- E27M2 - Turbofan Oven - 2 Tray Convection Oven.
- E27M3 - Turbofan Oven - 3 Tray Convection Oven.
- E28M4 - Turbofan Oven - 4 Tray Convection Oven.

Introduction	2
Safety Information	
Specifications	3
Installation	4
Installation Requirements	
Unpacking	
Location	
Clearances	
Stand Mounted Ovens	
Electrical Connection	
Positioning and Levelling of Oven	
Initial Start-Up	
Operation	6
Operation Guide	
Oven Control Panel	
Description of Controls	
Using the Oven	
Cleaning and Maintenance	7
Cleaning Guidelines	
Oven Cleaning	
Periodic Maintenance	
Fault Finding	10
Electrical Schematics	11
Replacement Parts List	13

Introduction

Before using your new oven, please read this instruction manual carefully, pay particular attention to any information labelled '**WARNING**', '**CAUTION**', '**IMPORTANT**' or '**NOTE**' in this manual.

 **Warning** Indicates a hazardous situation which, if not avoided, will result in death or serious injury.

 **Caution** Indicates a hazardous situation which, if not avoided, will result in minor or moderate injury.

If you are unsure of any aspect of the installation, instructions or performance of your oven, contact your TURBOFAN dealer promptly. In many cases a phone call could answer your question.

Should you contact your TURBOFAN dealer on any matter concerning this oven, please have the information provided opposite, readily available.

This manual must be kept by the owner for future reference.

A record of the **Date of Purchase**, **Date of Installation** and **Serial Number of the oven** should be recorded in the area provided below.

The serial number of this oven can be found on the Technical Data Plate located on the front right hand side panel, see diagram in 'Installation Section'.

Model Number:

Serial Number:

Dealer:

Service Provider:

Date Purchased:

Date Installed:

Safety Information

For your safety, please pay attention to the following symbols marked on the appliance.

- Risk of electric shock.



No user serviceable parts inside.

Qualified service person access only.

Disconnect from power before servicing.

Specifications

E22M3

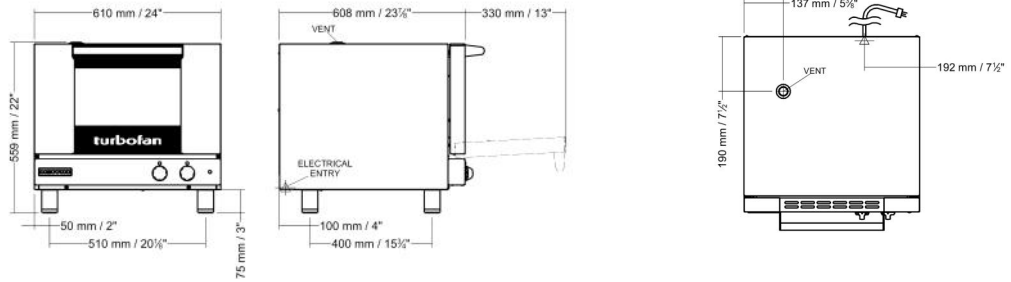

E23M3

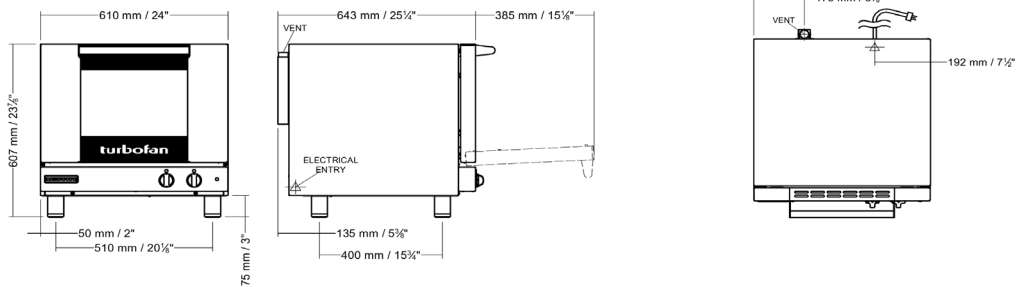

E27M2 / E27M3

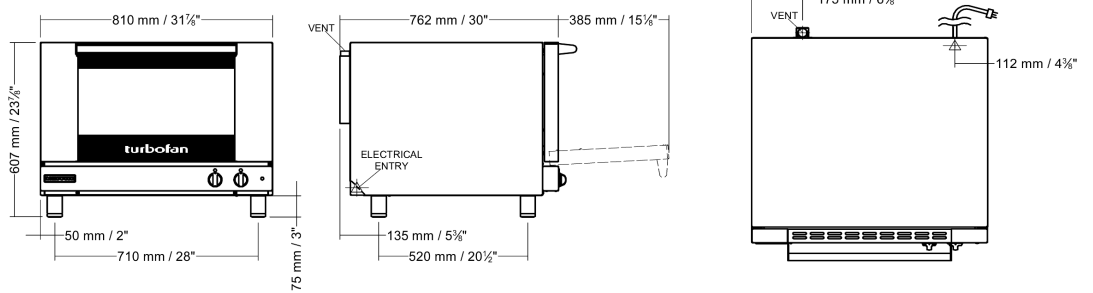

E28M4

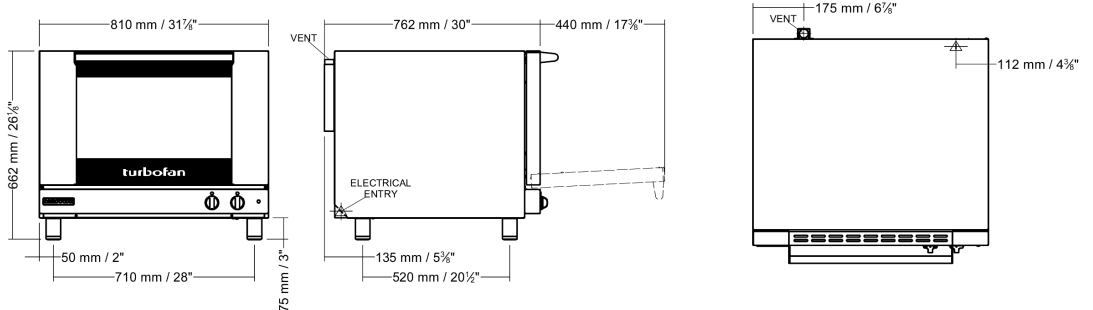

Oven Power Ratings

E22M3	110-120V, 1P+N+E, 60HZ, 1.5 kW
	220-240V, 1P+N+E, 50/60HZ, 2.0 kW
E23M3	208V, 1P+N+E, 50-60 HZ, 2.7 kW
	220V, 1P+N+E, 50-60 HZ, 3.0 kW
	230-240V, 1P+N+E, 50-60 HZ, 3.0 kW
E27M2	208V, 1P+N+E, 50-60HZ, 2.7kW
	220V, 1P+N+E, 50-60HZ, 3.0kW
	230-240V, 1P+N+E, 50-60HZ, 3.0kW
E27M3	208V, 1P+N+E, 50-60HZ, 4.2kW
	220V, 1P+N+E, 50-60HZ, 4.7kW
	230-240V, 1P+N+E, 50-60HZ, 4.7kW
E28M4	208V, 1P+N+E, 50-60HZ, 5.4kW
	220V, 1P+N+E, 50-60HZ, 6.0kW
	230-240V, 1P+N+E, 50-60HZ, 6.0kW

Oven Tray Details

	Tray Capacity	Tray Spacing
E22M3	3 x EN 2/3 Tray 3 x US 1/2 Pan	70 mm / 2 3/4"
E23M3	3 x EN 2/3 Tray 3 x US 1/2 Pan	85 mm / 3 1/3"
E27M2	2 x EN 600 x 400 mm Tray 2 x US Full Pan	110 mm / 4 1/3"
E27M3	3 x EN 600 x 400 mm Tray 3 x US Full Pan	85 mm / 3 1/3"
E28M4	4 x EN 600 x 400 mm Tray 4 x US Full Pan	76 mm / 3 "

Installation

Installation Requirements

Important:

- Installation shall comply with local electrical, health and safety requirements.
- It is most important that this oven is installed correctly and that oven operation is correct before use.
- If you have any questions regarding the proper installation and / or operation of this oven, please contact your local Turbofan distributor.

Unpacking

1. Remove all packaging and transit protection including all protective plastic coating from the exterior stainless steel panels.
2. Check the oven and supplied parts for damage. Report any damage immediately to the carrier and distributor.
3. Check that the following parts have been supplied with your oven:-
 - 4 x Leg Adjustable.
4. Report any deficiencies to the distributor who supplied your oven.
5. Securely fit the 4 legs supplied with the oven.
6. Check that the available electrical supply is correct to that shown on the Technical Data Plate located on the front right hand side panel.

- Refer to 'Specifications' section, 'Oven Specifications Tables'.

Location

1. Position the oven in its approximate working position.
2. The unit should be positioned so that the control panel and oven shelves are easily reachable for loading and unloading.



Technical Data Plate - Location

Clearances

To ensure correct ventilation for the motor and controls, the following minimum installation clearances are to be adhered to:-

Rear	25 mm / 1"
LH Side	25 mm / 1"
RH Side	25 mm / 1"

CLEARANCE FROM SOURCE OF HEAT.

A minimum distance of 300mm (12") from the appliance sides is required.

Important:

The vent located at the top (E22 Ovens) or rear (Other 20 Series Ovens) of the oven must NOT be obstructed.

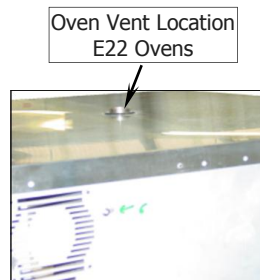

Stand Mounted Oven

For ovens that are to be mounted to a stand, the oven feet are used to level the oven on the stand. Refer to the instructions supplied with separately ordered stands for mounting details.

Installation

Electrical Connection



Warning

This oven must be earthed / grounded.

If the supply cord is damaged, it must be replaced by a suitably qualified person in order to avoid a hazard.

Each oven should be connected to an adequately protected power supply and an isolation switch mounted adjacent to, but not behind the oven and must be readily accessible to the operator. This switch must be clearly marked and readily accessible in case of fire.

Check the electricity supply is correct to as shown on the Technical Data Plate on the front right hand corner of the oven side panel.

Ovens Supplied with Cordsets.

1. Ensure that the oven is fitted with the appropriate power cord and plug.

Ovens Supplied without Cordsets.

NOTE: All electrical connections must only be carried out by a suitably qualified person.

1. Remove oven rear cover panel.
2. Bring the supply cable up through the grommet at the back of oven and through the compression gland on the electrical switchgear panel.
3. Connect the mains supply to the appropriately marked terminals on the terminal block.

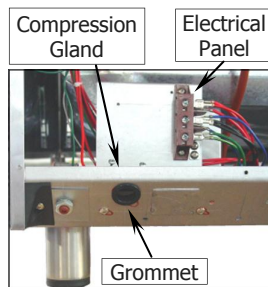

L1 Phase	L2 Neutral	Ground
RED	BLACK	GREEN
BROWN	BLUE	GREEN/YELLOW
BLACK	WHITE	

WARNING: THIS APPLIANCE MUST BE GROUNDED / EARTHED

NOTE:

- Fixed wiring installations must incorporate an all-pole disconnection switch.

Positioning and Levelling of Oven

1. Correctly locate the oven into its final operating position and using a spirit level, adjust the legs so that the oven is level and at the correct height.
2. Adjust the oven feet to level the oven.

Initial Start-Up

Before using the new oven;

1. For first time use of the oven, operate the oven for about 1 hour at 200°C / 400°F to remove any fumes or odours which may be present.
2. Please refer to the Operation Section of this manual for details on how to correctly operate and shutdown the oven.

Operation

Operation Guide

- Turbofan Ovens have been designed to provide simple operation.
- This oven is intended for use in a commercial kitchen and must only be put to the use for which it was intended, i.e. cooking food product. To use this oven correctly please read the following sections carefully:-

Oven Control Panel

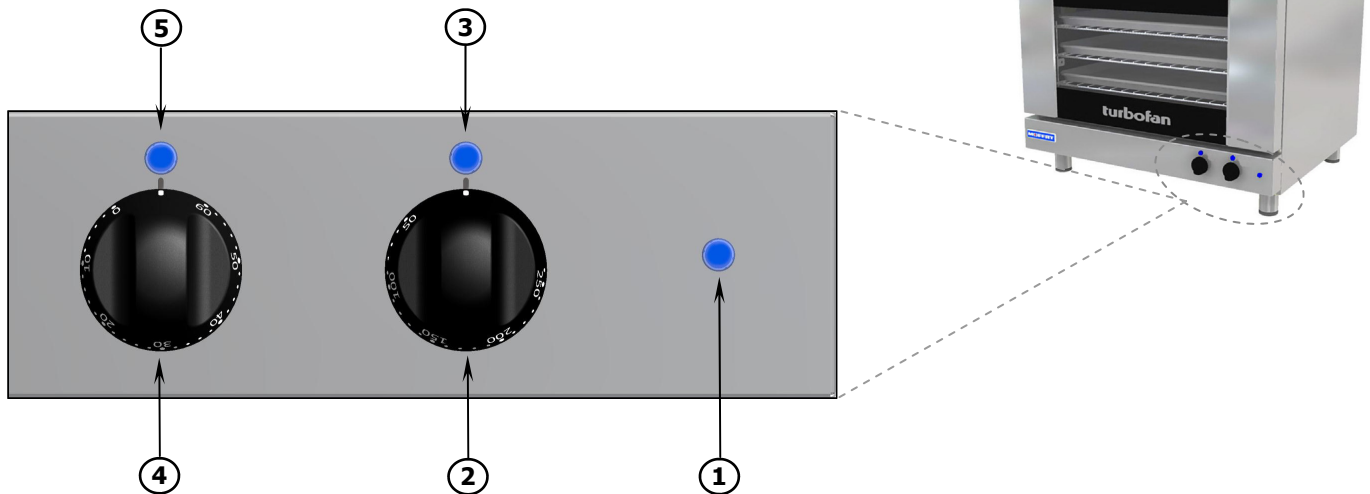

Description of Controls

- 1 Power 'On' Indicator Light.**
Indicator light illuminates when the 'On' / 'Off' - 'Temperature' control is turned 'On'.
- 2 'On' - 'Off' and 'Temperature Control'.**
Used to turn the oven 'On' / 'Off' and to select the oven temperature. Also turns the oven interior light 'On' / 'Off'. (Not E22M3).
- 3 Oven Heating Indicator Light.**
Indicator light illuminates when the elements are cycling 'On'. The oven heating indicator light will turn 'Off' when the oven is up to temperature.
- 4 Timer Control (60 Minute).**
Used to set the bake time. At any stage, the time can be adjusted in either direction. For settings less than 10 minutes, first set to a higher setting, then turn the timer down to the time required.
- 5 Time Up Indicator Light.**
Indicator light illuminates and the oven buzzer will sound when baking is complete.

Using the Oven



Caution

Some parts of this oven will become VERY HOT during use and could cause burns if touched accidentally.

To Turn 'On' the Oven;- Rotate 'Temperature' Control (2) from the 'Off' position. 'Power On' Indicator light (1) illuminates.

To Set the Temperature;- Rotate 'Temperature' Control (2) to the temperature required. 'Oven Heating' indicator light (3) will remain 'On' until the oven is up to temperature.

To Load the Oven;- open the oven door and load product. Avoid delays in loading the oven as this will delay the oven's temperature recovery.

To Set the Timer;- Rotate the 'Timer Control' (4) to the required time.

NOTE: This oven can be used without using the 'Timer Control', as it is purely a timer and does not control the baking operation of the oven.

Time Up;- When the timer reaches 0 minutes the buzzer sounds and the 'Time Up' indicator light (5) illuminates. To cancel buzzer, turn Timer Control (4) to the 'Off' position.

To Turn 'Off' the Oven;- Rotate 'Temperature' Control (2) to 'Off' position. 'Power On' light (1) will turn 'Off'.

Cleaning and Maintenance

Cleaning Guidelines



Caution

Always turn off electrical power at the mains supply before commencing cleaning.

This oven is not water proof. Do not use water jet spray to clean interior or exterior of the appliance.

To achieve the best results, cleaning must be regular and thorough. If any small faults occur, have them looked at promptly. Don't wait until they cause a complete breakdown.

NOTE:

- Carefully read and follow the safety instructions on the label of the cleaning product to be used.
- DO NOT use harsh abrasive scouring pads or abrasive detergents as they could damage the oven.
- Ensure that any detergent or cleaning material has been completely removed after each cleaning.

To keep your oven clean and operating at peak efficiency, follow the procedures shown below:-

Oven Cleaning

NOTE:

- If the oven usage is very high, the cleaning procedure should be carried out on a more frequent basis.
- Allow the oven interior to cool to approx 50°C / 120°F before commencing cleaning.

Stainless Steel Surfaces

- Thoroughly clean the exterior surfaces of the oven with a damp cloth moistened with a mild detergent solution or a soft bristled brush.
- Baked on deposits or discolouration may require a good quality stainless steel cleaner. Always apply cleaner when the oven is cold and rub in the direction of the grain.

Side Racks

- Remove the wire oven racks.
- Partially undo the rack / baffle securing screw (anti-clockwise) securing the rack to oven wall, until the rack is loose.

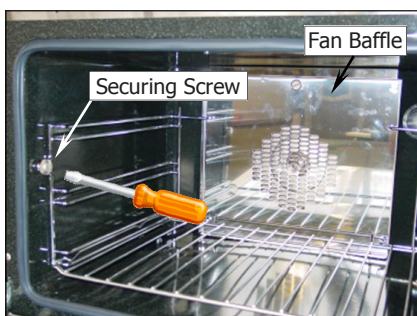

- Pull racks forward to disengage the location pins at the rear of rack from the fan baffle, remove the side racks from the oven.

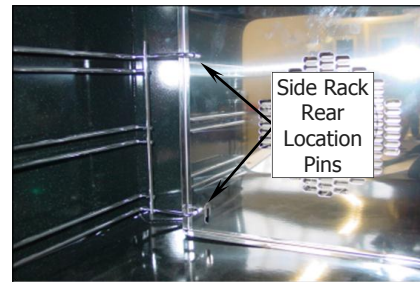

- Clean all racks with a mild anti bacterial detergent and hot water, using a soft bristled brush.
- Dry the racks thoroughly with a dry cloth.
- To refit the racks, engage the locating pins at the rear of side rack into the locating holes in the fan baffle at the rear of the oven.
- At the same time locate the front of the rack over the rack / baffle securing screw and hand tighten the rack / baffle securing screw.
- Refit the wire oven racks to the oven.

Fan Baffle (Not E22M3)

- Remove side racks as shown previously.
- Undo (anti-clockwise) and remove the rack / baffle securing screw at the top of the fan baffle. (E27 / E28 Ovens, have 2 rack / baffle securing screws).

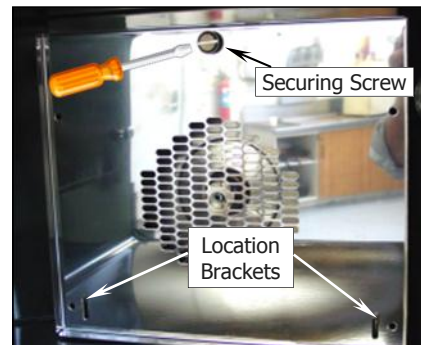

- Tilt the fan baffle forward and lift up off the location brackets at rear of oven.
- Clean the fan baffle with mild anti bacterial detergent and a hot water solution using a soft bristled brush.
- Dry fan baffle thoroughly with a soft dry cloth before re-fitting.
- Refit the fan baffle and hand tighten the rack / baffle securing screw(s) to secure the fan baffle.

Cleaning and Maintenance

Lamp Glass (Not E22M3)

- With side racks and fan baffle removed, unscrew lamp glass, anti-clockwise.



- Remove seal fitted between lamp glass and holder.



- Clean the lamp glass using a soft cloth with a mild anti bacterial detergent and a hot water solution.
- Dry the lamp glass thoroughly with a dry cloth.
- To refit the lamp glass, screw the glass in clockwise. **Do not over tighten the lamp glass.**

Door Seal

- To remove door seal, pull 1 piece seal forward until it pulls out of groove around oven. **Note way seal is fitted to oven, with lip facing inwards.**



- Check for wear and damage to door seal and replace as required.
- Wash door seal in a sink, take care not to cut or damage seal.
- Dry the door seal thoroughly.
- Refit door seal with lip facing into centre of oven.



- Press door seal into locating groove in front face of oven until seal is properly located all around oven.

Oven Interior

- Allow the oven interior to cool to approx 50°C / 120°F before commencing cleaning.

- Remove the oven racks and the fan baffle as shown previously.
- Clean any build up of grease from the oven interior, using a mild anti bacterial detergent, a hot water solution and a soft bristled brush.
- Dry the oven thoroughly with a soft dry cloth.
- Clean the oven regularly with a good quality oven cleaner.

Door Glass Cleaning

- Ensure that the oven door is cool before cleaning the door glass.

- Open the oven door.

NOTE: Maintain a hold of the door with one hand whilst cleaning the inner glass, to prevent the door from closing.

- Whilst holding the oven door in the open position, grasp the bottom of the inner glass and pull glass towards you until the top of the inner glass rises up.

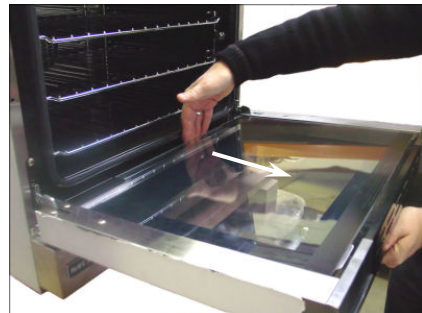

- Grasp the inner glass by the finger tabs at the top of the glass and raise the inner glass to the vertical

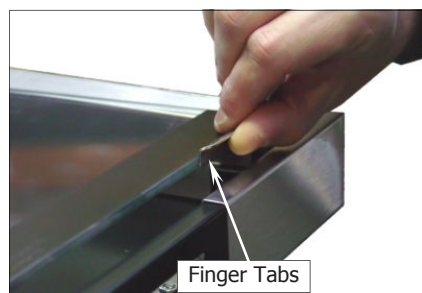

Cleaning and Maintenance

- d. Whilst still holding the oven door in the open position, clean the inner glass and the inside of the outer glass with a conventional glass cleaner.



- e. Dry the oven glass thoroughly with a soft dry cloth.
f. On completion of door glass cleaning, lower the inner glass back into the door, the glass will locate itself in the correct position.
g. Close the oven door.

Door Inner Glass Removal

It is possible to remove the inner glass completely from the oven door for heavy cleaning. This can be done as follows:-

- a. Open the oven door fully.
b. Using a suitable instrument, move the door lock catches from the unlocked to the locked position to prevent the door from closing.

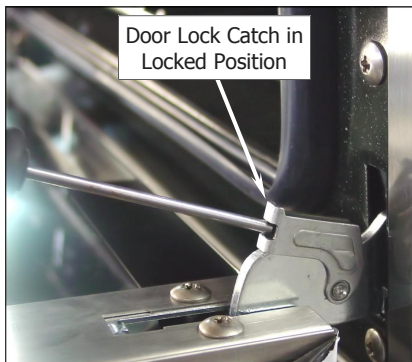
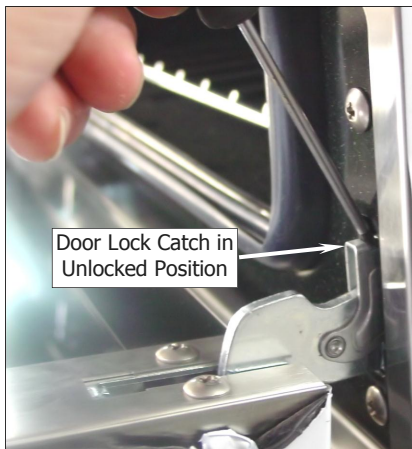

- c. Raise the door until it is restrained by the door lock catches.

- d. Grasp inner glass firmly on either side and pull upwards to remove inner glass from locating pegs on either side of door.

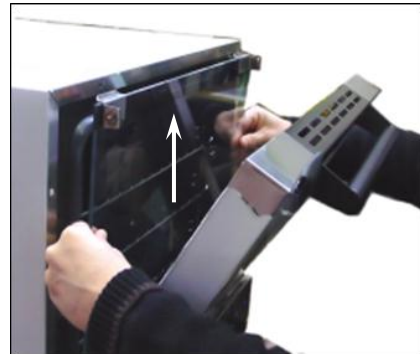

Door Inner Glass Re-Fitting

- a. To refit inner glass, locate 2 locating tabs on either side of inner glass into 2 pegs on door and push down on inner glass until it locks firmly into position.

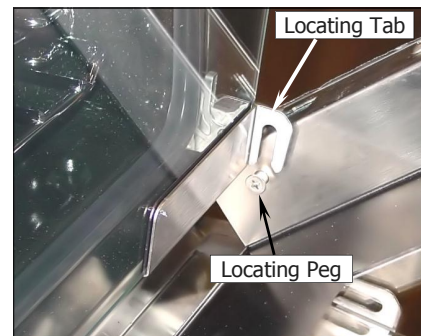

- b. Lower inner glass back into door, glass will locate itself in correct position.
c. Open oven door fully and using a suitable instrument, move door lock catches to unlocked position.



NOTE: Check that both Door Lock Catches are in the 'Un-Locked' position before closing the door.

- d. Close the oven door.

Periodic Maintenance

NOTE: All maintenance operations should only be carried out by a qualified service person.

Controls and mechanical parts should be checked and adjusted periodically by a qualified service person. It is recommended that appliance is serviced every 6 months.

Fault Finding

This section provides a reference to the more common problems that may occur during the operation of your oven. This fault finding guide is intended to help you correct and accurately diagnose problems with your oven.

You may encounter a problem not covered in this section, please contact your service provider who will require the following information:-

When fault finding a problem, always use a process of elimination starting with the simplest solution and working through to the most complex. Never overlook the obvious.

- **The Model and Serial Number of the oven, can be found on the Technical Data Plate located on the front right hand side panel of the oven.**

Fault	Possible Causes	Remedy
Oven does not operate / No heat in oven.	Fuse Blown (E27M3 - E28M4 Only).	Call for service.
	Mains isolating switch, circuit breaker or fuses are 'Off' at the power board.	Turn 'On'.
	Door not closed fully.	Close door. (Refer 'Door does not close fully').
	The external power switch is 'On', the oven is 'Off'. (Not E22).	Turn 'On' the 'On-Off Temp Control' switch. ('Power On' light will illuminate when oven is 'On') (Not E22).
	Overtemp tripped (No lights, no power light).	Reset Overtemp.
	Overtemp faulty.	Call for service.
	Element faulty.	Call for service.
	Thermostat faulty.	Call for service.
	Door Switch faulty.	Call for service.
	On / Off Switch faulty.	Call for service.
Oven heats up but fan does not operate.	Heating Relay faulty (Not E22M3).	Call for service.
	Motor timer faulty (Not E22M3).	Call for service.
	Fan motor faulty.	Call for service.
Door does not close fully.	Fan or fan motor obstructed.	Call for service.
	Tray in way of door.	Correctly position tray on rack.
	Door Latches in 'Locked' position.	Check position of door latches and 'Unlock'.
	Door glass not fitted correctly.	Refit door glass.
	Door not fitted correctly.	Refit door.
Oven Door hot to touch	Door seal obstruction.	Correctly install door seal. (Refer to the 'Cleaning and Maintenance' Section).
	Inner glass not fitted.	Fit inner door glass.
Bake timer does not time down.	Bake timer not set correctly.	For settings less than 10 minutes, first set timer to a higher setting then turn back to setting required.
	Bake timer faulty.	Call for service.
Oven light not illuminating (Not E22M3).	Blown bulb.	Replace bulb.
	Too high a temperature selected.	Select a lower temperature.
	Oven or racks not level.	Check oven racks and level.
	Insufficient air space around trays or baking tins.	Ensure oven racks are spaced to allow air flow around baking on all shelves.
	Oven overloaded with too much product.	Re-load oven with less product.
	Opening oven door un-necessarily.	Ensure oven door remains closed during the baking process.
	Oven door seal damaged or faulty.	Check seals and replace if damaged.
	Oven vent restricted.	Ensure oven vent not blocked or shrouded.
	Faulty thermostat.	Call for service.
	Uneven cooking.	

Electrical Schematics

Electrical Schematic E22M3 Turbofan Oven

110-120V, 60Hz.
220-240V 50/60Hz.

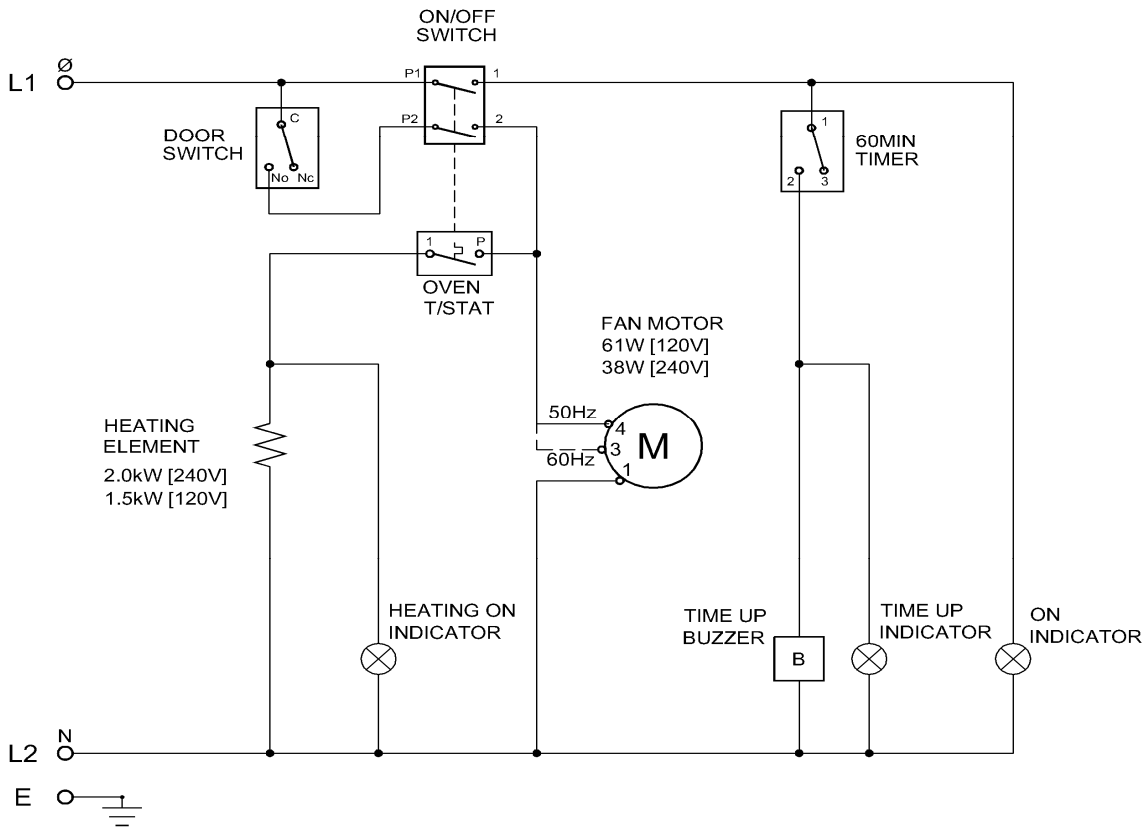

Electrical Schematic E23M3 Turbofan Oven

208V, 50-60Hz.
220V, 50-60Hz.
230-240V, 50-60Hz.

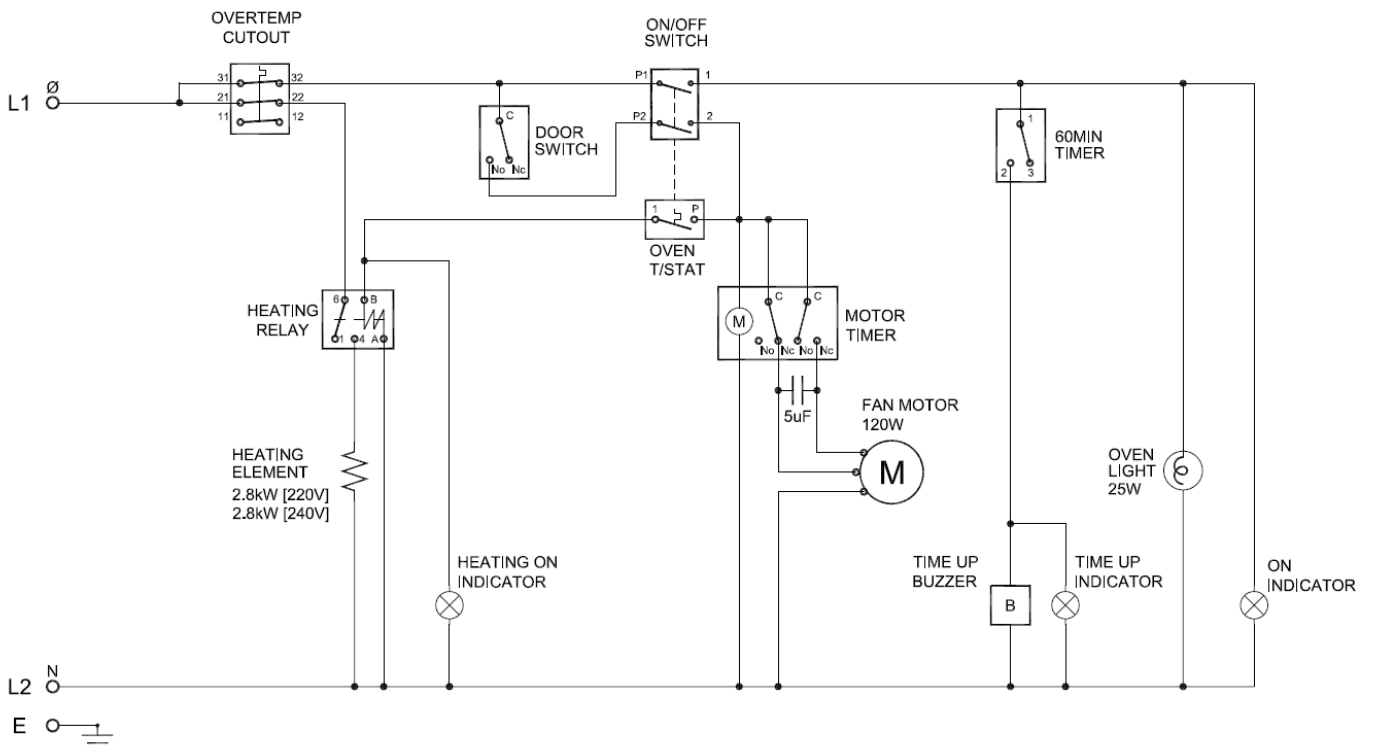

Electrical Schematics

Electrical Schematic E27M2 Turbofan Oven

208V, 50-60Hz.
220V, 50-60Hz.
230-240V, 50-60Hz.

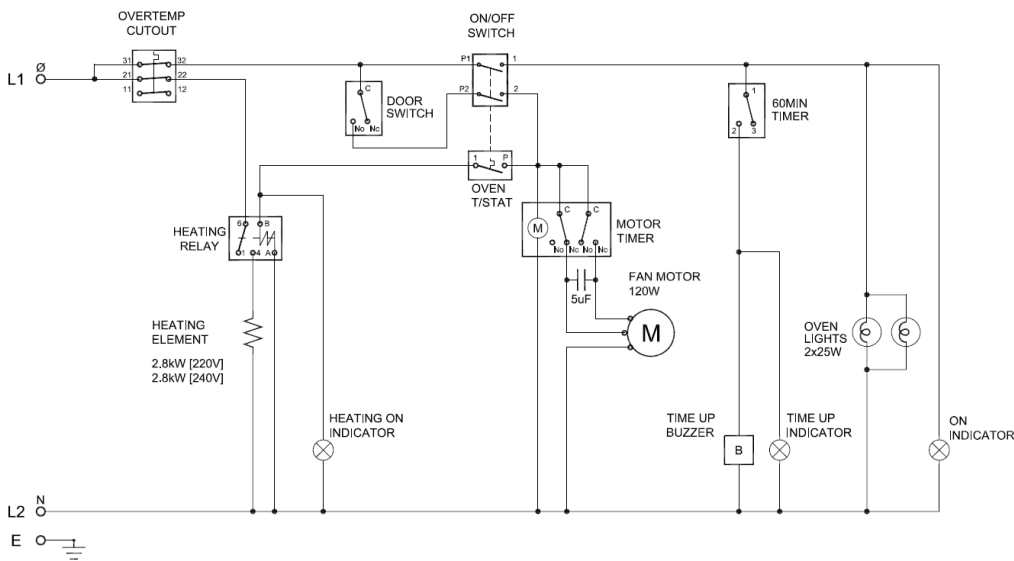

Electrical Schematic E27M3 Turbofan Oven

208V, 50-60Hz.
220V, 50-60Hz.
230-240V, 50-60Hz.

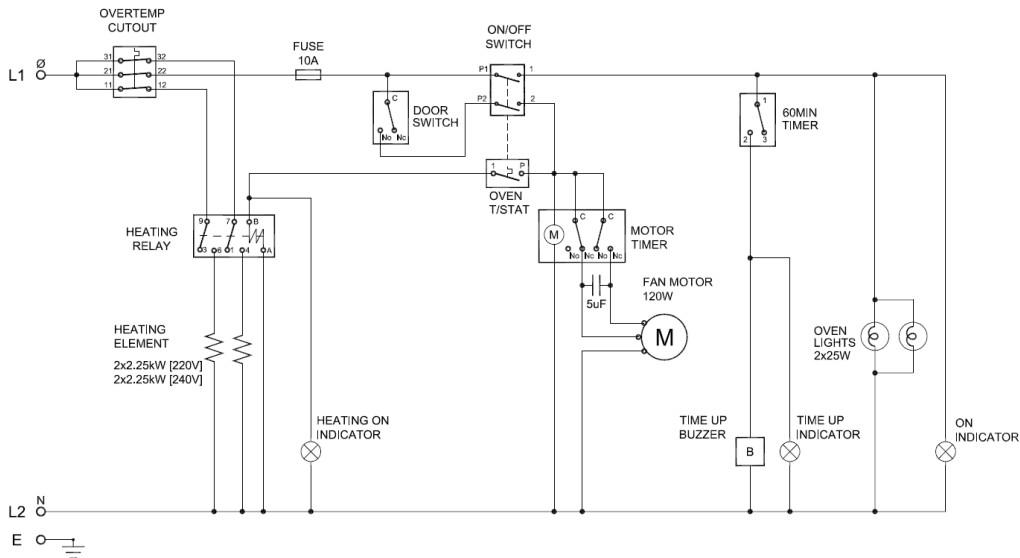

Electrical Schematic E28M4 Turbofan Oven

208V, 50-60Hz.
220V, 50-60Hz.
230-240V, 50-60Hz.

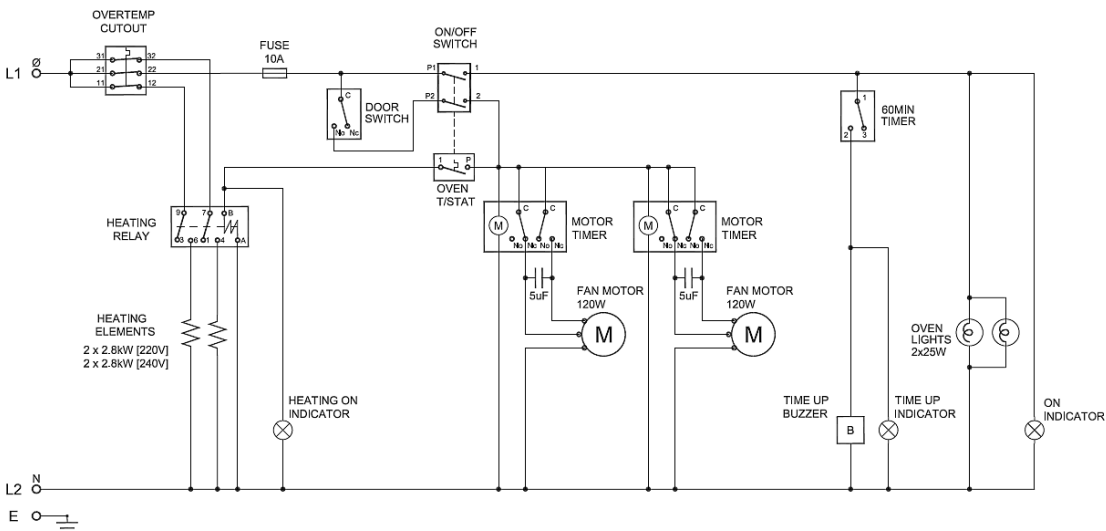

Replacement Parts List

Important:

Only genuine authorized replacement parts should be used for the servicing and repair of this oven. The instructions supplied with the parts should be followed when replacing components. For further information and servicing instructions, contact your nearest authorized service provider or Turbofan Dealer.

When ordering replacement parts, please quote the part number and the description as listed below. If the part required is not listed below, request the part by description and quote model number and serial number which is shown on the Technical Data Plate.

Item	Description	E22	E23	E27M2 / E27M3	E28
232765	Oven Element, 1500W, 110 - 120V	●			
232766	Oven Element, 2000W, 230 - 240V	●			
234088	Oven Element, 2800W, 230 - 240V		●	● M2 only	●
234089	Oven Element, 2800W, 208 - 220V		●	● M2 only	●
234107	Oven Element, 4500W, 208 - 220V			● M3 only	
234108	Oven Element, 4500W, 230 - 240V			● M3 only	
025387	Fan Motor, 110 - 120V	●			
013431K	Fan Motor, 50 / 60Hz, 208 - 240V	●			
235585	Fan Motor Kit, 129W, 208 - 240V, 50 / 60Hz		●	●	●
024503	Motor Timer, 230V		●	●	●
024562	Relay, 25A				●
024505	Relay, 30A		●	●	
234802	Fuse Holder			● M3 only	●
234803	Fuse 10A, 250V			● M3 only	●
234821	Overtemp, 355°C / 670°F - 20k		●	●	●
233573	Overtemp Cap		●	●	●
233607	Thermostat, 50 - 260°C / 150 - 500°F	●	●	●	●
233887	Rotary ON / OFF Switch	●	●	●	●
233616	Knob Thermostat, 50 - 260°C	●	●	●	●
233617	Knob Thermostat, 150 - 500°F	●	●	●	●
233862	Door Microswitch	●	●	●	●
234251	Capacitor 5uF		●	●	●
234136	LED Indicator, 110 - 250V	●	●	●	●
011760	Bake Timer 60 Minute	●	●	●	●
233613	Knob Bake Timer (0 - 60 Minute)	●	●	●	●
015822K	Buzzer, 110 - 120V	●			
011794K	Buzzer, 208 - 240V	●	●	●	●
233115	Oven Lamp Lens		●	●	●
233884	Lamp Bulb G9 25W, 120V Halogen		●	●	●
231814	Lamp Bulb G9 25W, 230V Halogen		●	●	●
233883	Oven Lamp Seal		●	●	●
233370	Door Inner Glass - E22	●			
233913	Door Inner Glass - E23		●		
233368	Door Inner Glass - E27			●	
233346	Door Inner Glass - E28				●
234602	Door Inner Glass Catch	●	●	●	●
233292	Door Hinge - E22	●			
233293	Door Hinge - E23		●		
233294	Door Hinge - E27			●	
233295	Door Hinge - E28				●
234465	Door Seal - E22	●			
232667	Door Seal - E23		●		
232666	Door Seal - E27M2 / E27M3			●	
234466	Door Seal E28				●
232379	Leg Adjustable (73 - 80 mm)	●	●	●	●

Replacement Parts List

Replacement Parts List (Continued).

Item	Description	E22	E23	E27M2 / M3	E28
233521	Side Rack LH, E22	•			
233522	Side Rack RH, E22	•			
232682	Side Rack LH, E23		•		
232683	Side Rack RH, E23		•		
233558	Side Rack LH, E27M3			• M3 only	
233559	Side Rack RH, E27M3			• M3 only	
234721	Side Rack LH, E27M2			• M2 only	
234722	Side Rack RH, E27M2			• M2 only	
233556	Side Rack, E28				•
233564	Oven Rack E22, E23	•	•		
233565	Oven Rack E27, E28			•	•
233552	Rack / Baffle Securing Screw	•	•	•	•

