



EVOLUTIONSERIES

INSTALLATION AND OPERATION MANUAL

ELECTRIC FRYERS

E43

E43E

E44

E44E



Date Purchased _____

Serial Number _____

Dealer _____

Service Provider _____

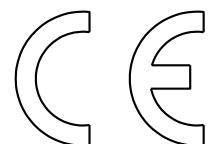

For use in GB & IE

229099-14

MANUFACTURED BY

Moffat Limited
Rolleston 7675
New Zealand

INTERNATIONAL CONTACTS

AUSTRALIA

Moffat Pty Limited

Web: www.moffat.com.au
E.Mail: vsales@moffat.com.au
Main Office: (tel) +61 (03) 9518 3888
(fax) +61 (03) 9518 3838
Service: (tel): 1800 622 216
Spares: (tel): 1800 337 963
Customer Service: (tel): 1800 335 315
(fax): 1800 350 281

CANADA

Serve Canada

Web: www.servecanada.com
E.Mail: info@servecanada.com
Sales: (tel): 800 551 8795 (Toll Free)
Service: (tel): 800 263 1455 (Toll Free)

NEW ZEALAND

Moffat Limited

Web: www.moffat.co.nz
E.Mail: sales@moffat.co.nz
Main Office: (tel): 0800 663328

UNITED KINGDOM

Blue Seal

Web: www.blue-seal.co.uk
E.Mail: sales@blue-seal.co.uk
Sales: (tel): +44 121 327 5575
(fax): +44 121 327 9711
Spares: (tel): +44 121 322 6640
(fax): +44 121 327 9201
Service: (tel): +44 121 322 6644
(fax): +44 121 327 6257

UNITED STATES

Moffat

Web: www.moffat.com
Sales: (tel): 800 551 8795 (Toll Free)
(tel): +1 336 661 1556
(fax): +1 336 661 9546
Service: (tel): 800 858 4477 (Toll Free)
(tel): +1 336 661 1556
(fax): +1 336 661 1660

REST OF WORLD

Moffat Limited

Web: www.moffat.co.nz
E.Mail: export@moffat.co.nz

The reproduction or copying of any part of this manual by any means whatsoever is strictly forbidden unless authorized previously in writing by the manufacturer.

In line with policy to continually develop and improve its products, Moffat Ltd. reserves the right to change the specifications and design without prior notice.

Blue Seal Electric Deep Fryer

E43	'Fast-Fri' Electric Fryer, Manual Control	(Single Tank - 27ltr - 17kW).
E43E	'Fast-Fri' Electric Fryer, Digital Control	(Single Tank - 27ltr - 17kW).
E44	'Fast-Fri' Electric Fryer, Manual Control	(Twin Tank - 24ltr - 17kW-Non-UK).
E44E	'Fast-Fri' Electric Fryer, Digital Control	(Twin Tank - 24ltr - 17kW-Non-UK).

Introduction	3
---------------------------	----------

Specifications	4
-----------------------------	----------

Model Numbers Covered in this Specification	
Electrical Supply Requirements	

Dimensions	5
-------------------------	----------

Installation	7
---------------------------	----------

Installation Requirements	
Unpacking	
Location	
Clearances	
Assembly	
Electrical Connection	
Commissioning	

Operation	9
------------------------	----------

Operation Guide	
Description of the Controls (E43 & E44 Fryers Only)	
Description of the Controls (E43E & E44E Fryers Only)	
Control Panel Functions - (E43E & E44E Fryers Only)	
Controller Basic Programming Mode - (E43E & E44E Fryers Only)	
Entering the Controller Basic Settings	
Setting the Parameters	
To Exit the Programming Mode	
Filling the Tank(s)	
Operation of the Appliance	
E43 and E44 Fryers Only	
E43E and E44E Fryers Only	
'Over Temperature' Control System	

Cleaning and Maintenance	16
---------------------------------------	-----------

General	
Draining and Daily Cleaning	
Weekly Cleaning	
Periodic Maintenance	

Contents

Fault Finding	19
Guide to Cooking Problems with Fryer	
Fault Finding the Electrical System	
Wiring Schematics	22
Controller Advanced Programming Mode	26
Timing Mode	
Temperature Offset	
Temperature Display Mode	
Programming the Melt Cycle	
Setting the Temperature Units	
System Programmable Default Settings	
Replacement Parts List	29

We are confident that you will be delighted with your BLUE SEAL Electric Deep Fryer, and it will become a most valued appliance in your commercial kitchen.

To ensure you receive the utmost benefit from your new Blue Seal Electric Deep Fryer, there are two important things you can do.

Firstly:

Please read the instruction book carefully and follow the directions given. The time taken will be well spent.

Secondly:

If you are unsure of any aspect of the installation, instructions or performance of your appliance, contact your BLUE SEAL dealer promptly. In many cases a phone call could answer your question.

CE Only:

These instructions are only valid if the country code appears on the appliance. If the code does not appear on the appliance, refer to the supplier of this appliance to obtain the technical instructions for adapting the appliance to the conditions for use in that country.



Warning

IMPROPER INSTALLATION, ADJUSTMENT, ALTERATION, SERVICE OR MAINTENANCE CAN CAUSE PROPERTY DAMAGE, INJURY OR DEATH. READ THE INSTALLATION, OPERATING AND MAINTENANCE INSTRUCTIONS THOROUGHLY BEFORE INSTALLING OR SERVICING THIS APPLIANCE.



Warning

THE OPERATOR MUST TAKE GREAT CARE TO USE THE EQUIPMENT SAFELY TO GUARD AGAINST RISK OF FIRE AND INJURY.

- **THE APPLIANCE MUST NOT BE LEFT ON UNATTENDED.**
- **IT IS RECOMMENDED THAT A REGULAR INSPECTION IS MADE BY A COMPETENT SERVICE PERSON TO ENSURE CORRECT AND SAFE OPERATION OF YOUR APPLIANCE IS MAINTAINED.**
- **DO NOT STORE OR USE GASOLINE OR OTHER FLAMMABLE VAPOURS OR LIQUIDS IN THE VICINITY OF THIS OR ANY OTHER APPLIANCE.**
- **DO NOT SPRAY AEROSOLS IN THE VICINITY OF THIS APPLIANCE WHILE IT IS IN OPERATION.**



Caution

- **This appliance is for professional use and is only to be used by qualified persons.**
- **Only authorised service persons are to carry out installation or servicing operations.**
- **Components having adjustments protected (e.g. paint sealed) by the manufacturer should not be adjusted by the user / operator.**
- **DO NOT operate the appliance without the legs supplied fitted.**

Specifications

Model Numbers Covered in this Specification

E43	'Fast-Fri' Electric Fryer, Manual Control	(Single Tank - 27ltr).
E43E	'Fast-Fri' Electric Fryer, Digital Control	(Single Tank - 27ltr).
E44	'Fast-Fri' Electric Fryer, Manual Control	(Twin Tank - 24ltr).
E44E	'Fast-Fri' Electric Fryer, Digital Control	(Twin Tank - 24ltr).

Electrical Supply Requirements



Warning

THIS APPLIANCE MUST BE EARTHED. IF THE SUPPLY CORD IS DAMAGED, IT MUST BE REPLACED BY A SUITABLY QUALIFIED PERSON IN ORDER TO AVOID A HAZARD.

Model	Power Supply			Total Power Input	Amps		
	Voltage	Type	Frequency		L1	L2	L3
E43 / E43E	400-415Vac	3 P+N+E	50 / 60Hz	17kW	23.6	23.6	23.6
E44 / E44E	400-415Vac	3 P+N+E	50 / 60Hz	17kW	23.6	23.6	23.6

Electrical Connection

When connecting a this electric appliance to the mains supply, ensure that the following is carried out:-

- The supply cord shall not be lighter than ordinary tough rubber sheathed (oil resistant) cord. e.g. H05 RN-F with sufficient current carrying capacity cable sizes.
- The branch supply line shall be overload protected.
- The point of connection shall be as close as practicable to the appliance have an isolating switch accessible during manual operation of the appliance.
- The supply cord shall be protected against any mechanical or thermal damage.

Refer to the appropriate wiring standards for the size of cable that is to be supplied to an appliance for the current drawn on that line.

E43 FRYER

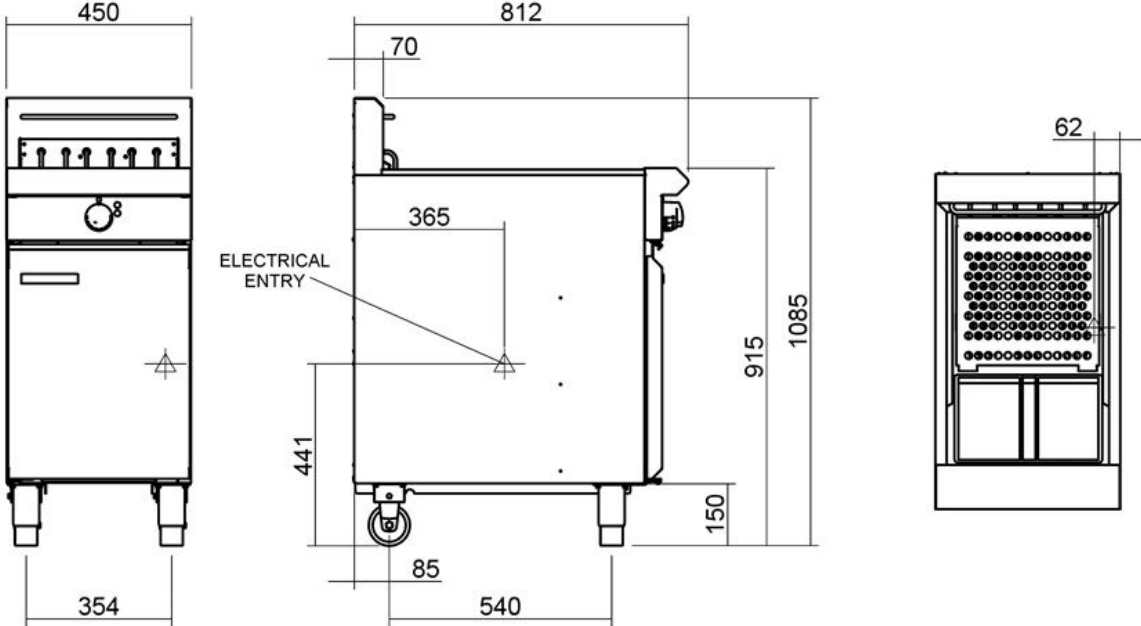

E44 FRYER

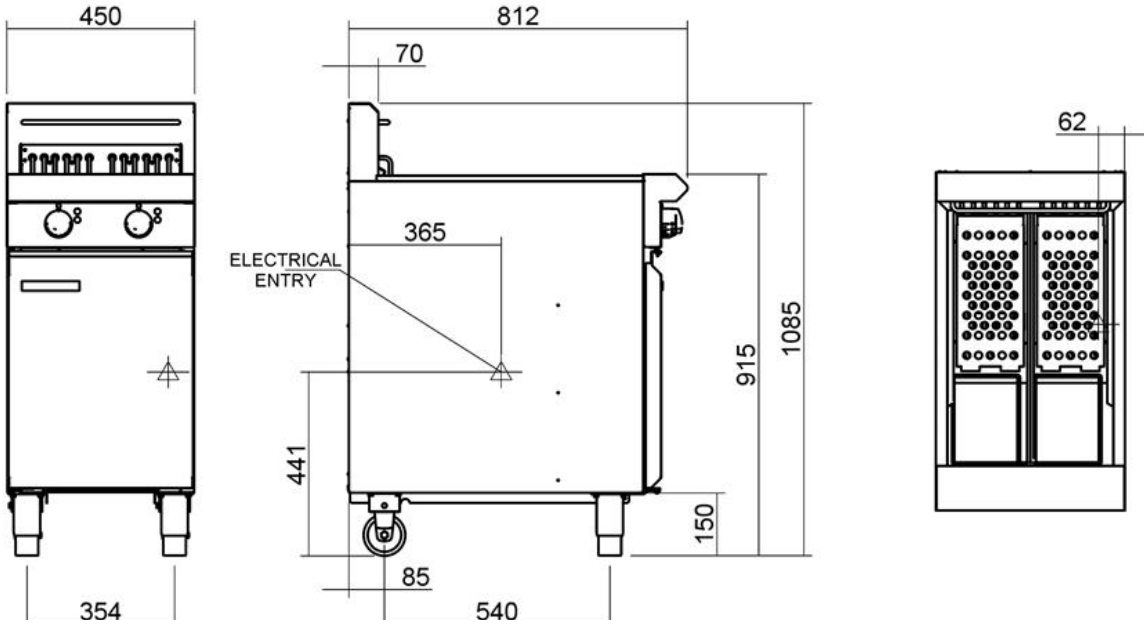

 Electrical Entry Point.

Dimensions

E43E FRYER

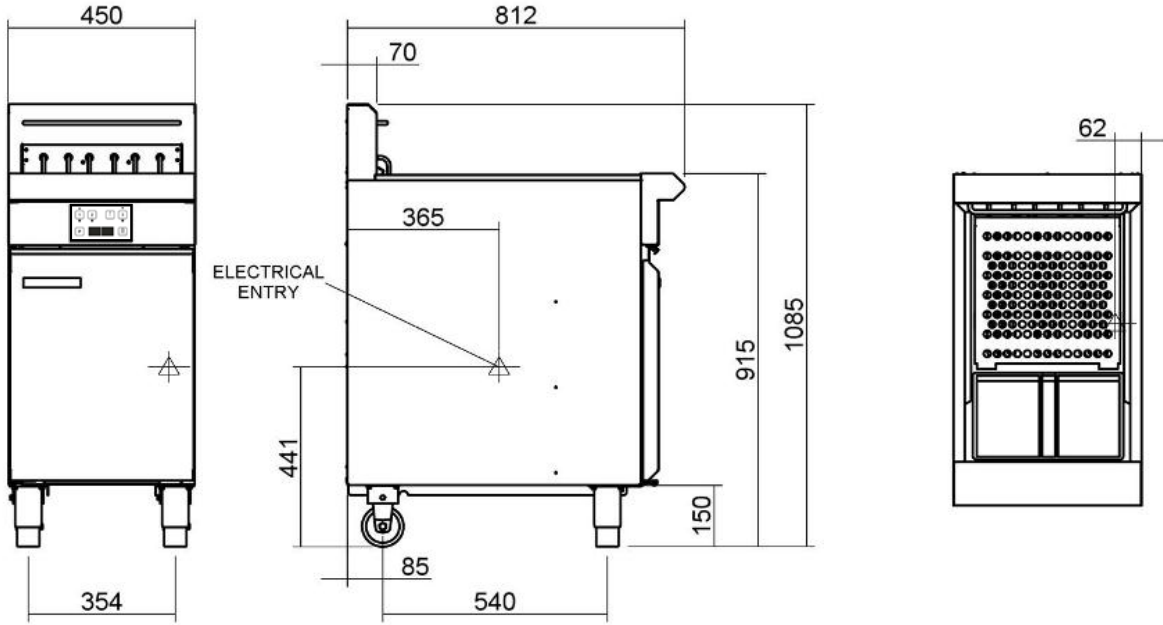

E44E FRYER

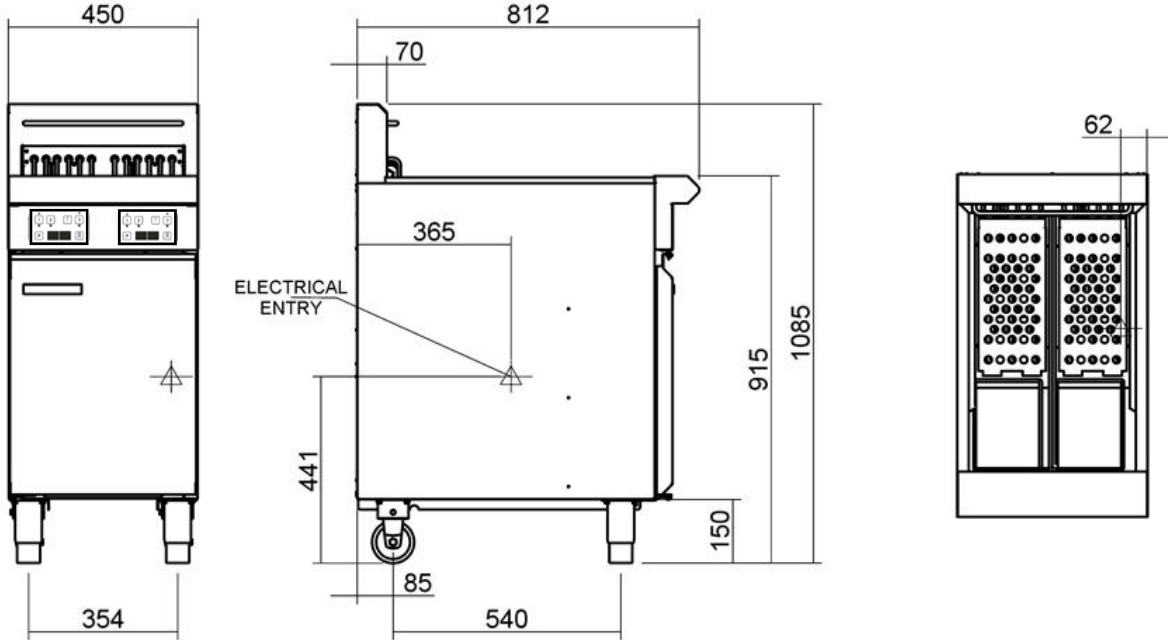

 Electrical Entry Point.

Installation Requirements

NOTE: It is most important that this appliance is installed correctly and that operation is correct before use. Installation shall comply with local electrical and health and safety requirements.

Blue Seal Deep Fryers are designed to provide years of satisfactory service, and correct installation is essential to achieve the best performance, efficiency and trouble-free operation.

This appliance must be installed in accordance with National installation codes and in addition, in accordance with relevant National / Local codes covering health and safety, electrical and fire safety.

Australia / New Zealand **AS / NZS3000** - Wiring Rules.
United Kingdom: **BS7671** - Requirements for Electrical Installations.

Installations must be carried out by qualified service persons only. Failure to install equipment to relevant codes and manufacturers specifications shown in this section will void the warranty.

Unpacking

- Remove all packaging and transit protection from appliance including all protective plastic coating from door outer panel and exterior stainless steel panels.
- Check equipment and parts for damage. Report any damage immediately to carrier and distributor.
- Report any deficiencies to distributor who supplied appliance.
- Check available electrical supply is correct to as shown on rating plate located on inside of access door.
- Check the following parts have been supplied with appliance:

	E43 / E43E	E44 / E44E
Baskets	2	2
Basket Grids	2	2
Lid	1	1
Drain Extension	1	2
Drain Stick	1	1

Location

1. Any appliance requires adequate clearance and ventilation for optimum and trouble-free operation. Minimum installation clearances shown below are to be adhered to.
2. Position the Deep Fryer in its approximate working position.
3. Legs must always be fitted. Ensure that the legs are securely attached.

Clearances

	Combustible Surface	Non Combustible Surface
Left / Right Hand Side	50mm	0mm
Rear	25mm	0mm

NOTE:

- Only non-combustible materials can be used in close proximity to this appliance.
- To allow easy operation, drainage and servicing of the appliance, a minimum of 600mm clearance should be maintained at front of appliance.

Assembly

This model is delivered completely assembled. Ensure that the legs are securely attached.

NOTE:

- This appliance is fitted with adjustable feet so that the appliance can be positioned securely and level. This should be carried out on completion of electrical connection. Refer to 'Electrical Connection' section overleaf.

Optional Accessories (Refer to Replacement Parts List)

- Plinth Kit. For installation details, refer to instructions supplied with each kit.

Installation

Electrical Connection

NOTE: ALL ELECTRICAL CONNECTIONS MUST ONLY BE CARRIED OUT BY A QUALIFIED PERSON.

Each fryer should be connected to an adequately protected power supply and an isolation switch mounted adjacent to, but not behind fryer. This switch must be clearly marked and readily accessible in case of fire.

1. Check electricity supply is correct as shown on Rating Plate attached to the inside of access door.
2. Supply terminal connections are located at lower front of fryer.
3. Open door and remove service panel (6 screws) located behind drain valve(s) to allow connection access for electrical supply.
4. Bring the supply cable up through the grommet at the rear of fryer, and through compression type gland provided on rear of main electrical switchgear panel.
5. Connect mains supply to L1, L2 and L3 switch connections for 3 phases.
6. Connect neutral and earth conductors to neutral stud and earth stud respectively.
7. For all connections, ensure that conductors are secure and appropriately terminated.
8. Tighten cable gland to secure against tension on cable.

NOTE:

- **This appliance must be grounded / earthed.**
- **Fixed wiring installations must incorporate an all-pole disconnection switch.**

Commissioning

1. Before leaving the new installation;
 - a. Check the following functions in accordance with the operating instructions specified in the 'Operation' section of this manual.
 - Check current draw and loading for equipment. Refer specification section for correct electrical requirements.
 - Check all connections are correct and that all cover panels have been re-fitted.
 - Check the unit functions in accordance with operating instructions.
 - Ensure that tank drain extension and this instruction manual are left with appliance.
 - Ensure that all relevant details and contacts have been added to front of this manual.
 - b. The thermostat operation check should be carried out by filling fryer with oil / shortening to appropriate oil 'FILL LEVEL' mark and setting thermostat to 180°C. Turn on elements as shown in 'Operation Instructions' in this manual.
 - c. Calibration of thermostat should be checked once oil is up to temperature. If a discrepancy is found, thermostat calibration should be referred to supplier.
 - d. Ensure operator has been instructed in the correct operation and shutdown procedure for appliance.

Initial Start-Up

Before using the fryer;

- a. For first time use of the fryer and before using for cooking product, fill fryer with oil and operate for about 1 hour at **Full Flame** setting to remove any fumes or odours which may be present in the new appliance.
- b. Refer to 'Operation' section of this manual for details on how to operate the fryer.
2. This manual must be kept by the owner for future reference, and a record of **Date of Purchase**, **Date of Installation** and **Serial Number of Appliance** recorded and kept with this manual. (These details can be found on Rating Plate fitted to inside of access door and in 'Specifications' section of this manual.

NOTE:

- **If it is not possible to get the fryer to operate correctly, turn 'Off' electrical power supply and contact a qualified service person. Appliance supplier will be able to recommend a suitable person.**
- **Make sure that the electrical supply is turned 'Off' before any service or maintenance work is carried out.**

Operation Guide

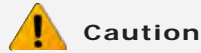

- This appliance is for professional use and is only to be used by qualified persons.
- Only authorised service persons are to carry out installation or servicing operations.

Description of the Controls (E43 and E44 Fryers Only)

E44 Manual Controls - Twin Tank



Fig 1

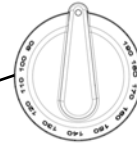

Temperature Control Knob
Temperature Graduations
60°C to 200°C.

Neon Indicator
(White)

Power 'ON' Indicator. (When main power switch is 'ON').

Neon Indicator
(Orange)

Heating 'ON' Indicator. (When thermostat is turned to a selected temperature.

Located Behind Main Access Door

Temperature
Cut-Out Reset
Switches

Operating the reset switch resets the element. (Press to operate).

Mains Isolation
Switch

Turns power 'ON' and 'OFF' to the unit. (White LED Indicator illuminates (Green) when switched 'ON').

Description of the Controls (E43E and E44E Fryers)

E43E Electronic Controls Single Tank



Fig 2

Electronic Controller
See description of Electronic Controller overleaf.

Located Behind Main Access Door

Temperature
Cut-out Reset
Switches

Operating the reset switches resets the elements. (One switch for each element. Press to operate).

Mains Isolation
Switch

Turns power 'ON' and 'OFF' to the unit. (Green LED Indicator illuminates when switched 'ON').

Operation

Control Panel Functions -E43E and E44E Fryers Only



Each control panel comprises the following:-

One 4 digit, seven segment display with a 0.5" high, bright green LED display.

Three green LED indicator lights located under each of the 3 Timer Controls.



6 Touch Control Keys:-



'ON' / 'OFF' Key.



Programme Key (P).



Left Timer - 'UP' Key and LED Indicator Light.



Centre Timer - and LED Indicator Light.



Right Timer - 'DOWN' Key and LED Indicator Light.



Temperature Key (Thermostat).

The 3 Timer Keys on each control panel can be used to program 3 different cook times for each tank.

NOTE: Only one temperature setting applies to all 3 timers.

Controller Basic Programming Mode - E43E and E44E Fryers Only

The following Parameters can be changed in Controller Basic Programming Mode:-

- Timer 1 - Cook Time Settings.
- Timer 2 - Cook Time Settings.
- Timer 3 - Cook Time Settings.
- Cooking Temperature Setting.
- Keypad 'Lock - Unlock' (Programming the Password Protection).

NOTE:

- Each Timer Key on the control panel can be individually programmed with a different cook time.
- The user cannot enter Basic Programming Mode whilst a timer is running. An alarm will sound indicating the key press, but access to programming mode will be blocked.

Entering the Controller Basic Settings

- To enter 'Programming Mode', press 'ON / OFF' key to turn 'ON' the control panel.
- Press Programme Key 'P' to access the parameter setting required.
 - If 'LoC' is displayed, control panel is locked which will prevent any accidental change to the operating mode.
 - To access parameters, whilst 'LoC' is displayed on screen, enter the passcode '1 1 3 3'.

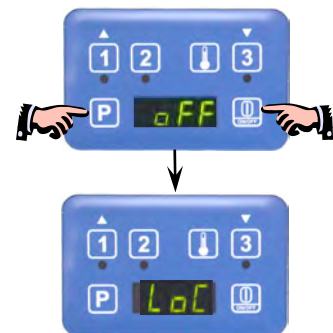

Setting the Parameters

- To change the settings, press either **1** or **3** Key until the value required is shown on the display.
- Press Programme Key 'P' to confirm new value and the change will be accepted. Display will step on to the next parameter.

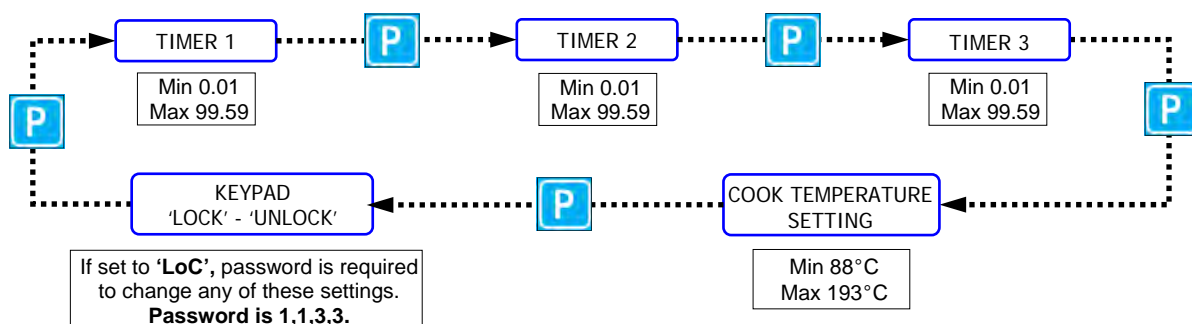

To Exit the Programming Mode.

To exit Programming Mode, press and hold Programme Key 'P' for approximately 3 seconds, **or** do not press any key for 2 minutes. The display will revert to 'Idle Mode'.

Operation

Filling the Tank(s)

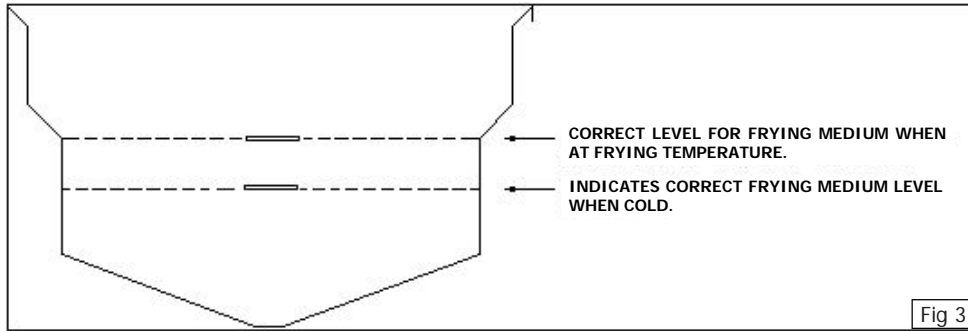

NOTE: BLUE SEAL 'Deep Fryers' can be used with both oil and shortening.

1. Before filling the tank, always check that the drain valve(s) behind the access door is (are) closed. A locking slide is provided on these valves and this should always be locked in position during use.
2. Ensure that the elements are swung down into the tank(s).

OIL - Carefully fill the fryer tank until the lower 'Fill Level' mark is reached.

Set the thermostat to the required operating temperature, the oil will expand as heated and will reach the upper level mark when the oil is hot (180 - 190°C).

- The E43 single tank fryer will hold 27 to 29 litres of oil.
- The E44 twin tank fryer will hold 14 litres of oil per pan.

SHORTENING - Ideally shortening should be pre-melted prior to putting it into the tank. This is normally done in a suitable vessel on a boiling table burner(s). The liquefied shortening can then be poured into the tank until it reaches the 'FILL LEVEL' mark.

- The E43 single tank fryer will hold 22 - 23kg of shortening.
- The E44 twin tank fryer will hold 11kg of shortening per tank.

Pre-Heating

NOTE: When pre-melting shortening, only heat the shortening until it is just liquefied. Do not bring the shortening up to high temperature as handling of hot shortening is dangerous.

- If pre-melting of shortening is not possible, carefully cut the shortening into small pieces and pack below, all around and above the elements, ensuring that the element can fully lower to operate the element tilt microswitch otherwise the fryer will not operate.

E43 and E44; - Set the tank control thermostat to 120°C and switch the appliance 'ON' for 30 seconds and then 'OFF' for 1 minute. Repeat the cycle until all the shortening is melted enough to apply full power to the heating elements. To speed up this process, break up the shortening and stir carefully during the melting process.

NOTE: Running the elements continuously will cause the shortening in contact with the tank to overheat, resulting in premature oil breakdown. Never allow the shortening to smoke while melting as this indicates that the temperature is too high. If the shortening starts smoking, increase the 'Off' intervals of the elements.

Operation of the Appliance



Warning

THE OPERATOR MUST TAKE GREAT CARE TO USE THE FRYER SAFELY AND TO GUARD AGAINST THE RISK OF INJURY AND FIRE.

- DO NOT LEAVE FRYER UN-ATTENDED DURING OPERATION.
 - DO NOT REPLENISH THE OIL (FRYING MEDIUM) IN THE FRYER WHEN THE FRYER IS HOT.
 - DO NOT OVER FILL THE OIL (FRYING MEDIUM) IN THE FRYER ABOVE THE TOP LEVEL MARK.
 - DO NOT ALLOW THE OIL (FRYING MEDIUM) IN THE FRYER TO FALL BELOW THE LOWER LEVEL MARK.
 - DO NOT ALLOW THE OIL (FRYING MEDIUM) IN THE FRYER TO OVERHEAT.
 - DO NOT INTRODUCE WET FOOD OR WATER INTO THE HOT OIL (FRYING MEDIUM).
 - DO NOT USE FLAMMIBLE SOLVENTS AND CLEANING AIDS ON OR IN CLOSE PROXIMITY TO THE FRYER WHILST THE FRYER IS STILL HOT.
-

E43 and E44 Models Only.

1. Turn 'ON' mains power at mains supply, ensure that Temperature Cut-Out Reset Switch has been reset (which is located behind front access door, one for each tank on twin tank fryers E44 and E44E).
2. Turn 'ON' Mains isolator switch which is located behind front access door. The Clear neon indicator will illuminate to indicate that there is mains power to the fryer.
3. Set the tank control thermostat to the temperature required. The Orange neon indicator will illuminate to indicate that a temperature has been set.
4. When the tank reaches the set temperature, the Orange neon will extinguish to indicate that the fryer is up to the correct temperature.
5. To turn 'OFF' the fryer, turn the tank control thermostat to the 'OFF' position.
6. Open the front access door and turn the Temperature Cut-Out Reset Switch to the 'OFF' position.
7. Turn 'OFF' the mains power at the mains supply.

Operation

E43E and E44E Fryers Only.

Fryer Operation (Flow Chart)

Refer to 'Controller Basic Programming Mode' at the start of this section for the basic programmable settings for the controller.

Refer to the 'Controller Advanced Programming Mode' section for controller advanced programming.

If Melt Cycle is turned ON.

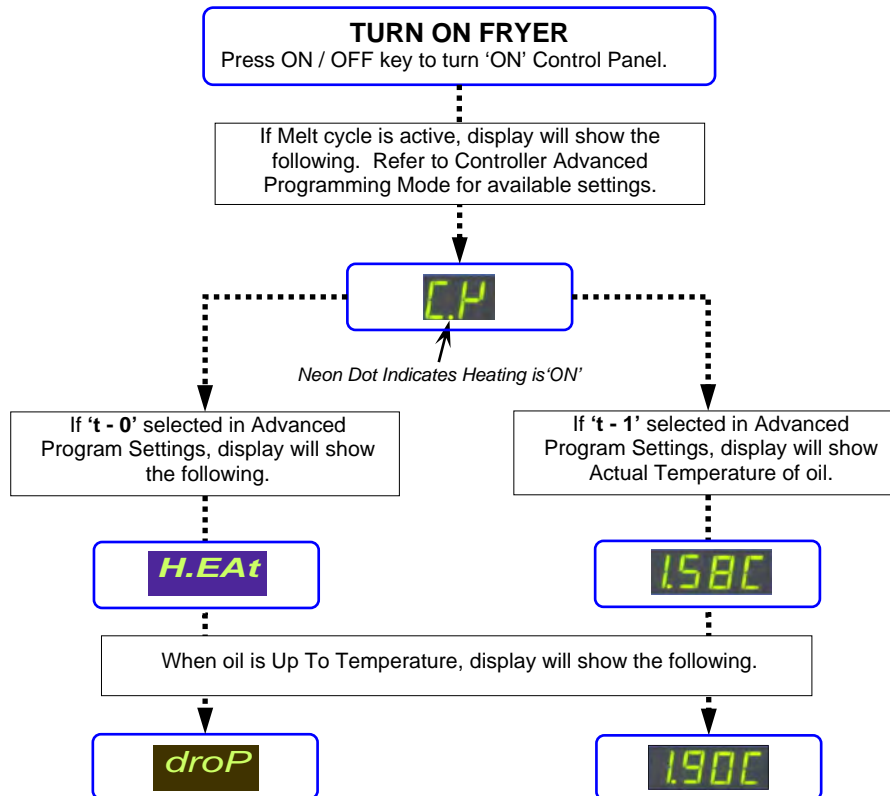

Fryer can now be used without using the Timers, if required.

If Melt Cycle is turned OFF.

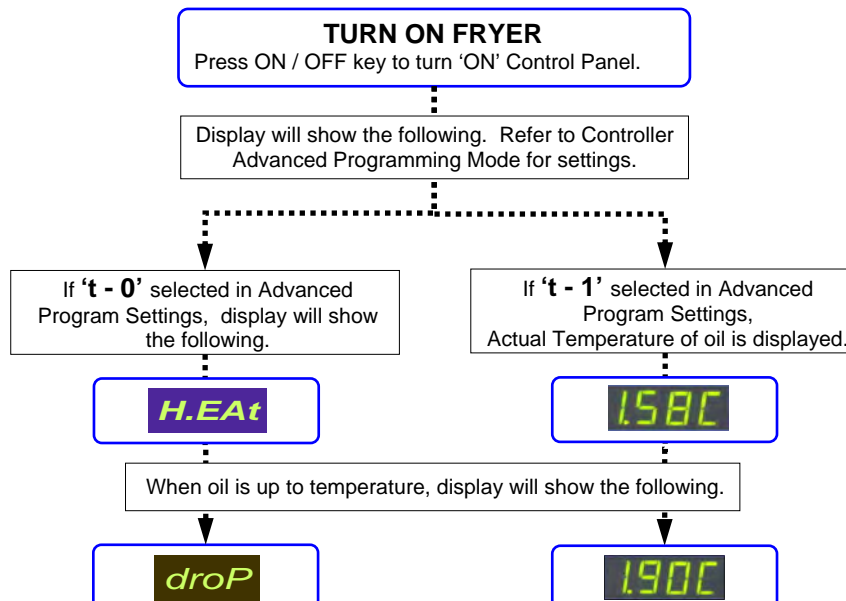

Fryer can now be used without using the Timers, if required.

To Use the Timers

NOTE: Refer to 'Basic Programming Mode' for information on how to set the Timer Pre-Set times.

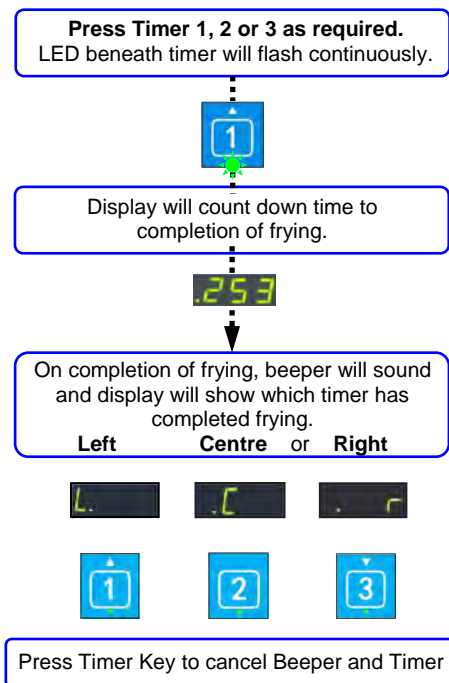

To Use the Temperature Display

NOTE: Refer to 'Basic Programming Mode' for information on how to set the Cooking Temperature.

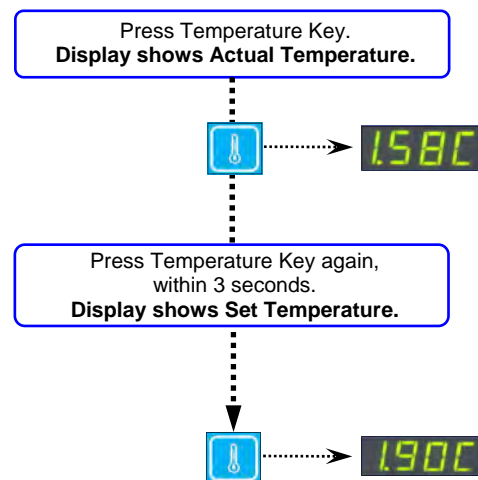

Turning 'OFF' the Fryer

1. Press the 'On /Off' Key on the control panel.
2. Turn 'Off' the power supply at the mains supply.

'Over-Temperature' Control System

These fryers have been fitted with a 'Fail Safe Over Temperature Safety Cut-Out' which will protect the oil / fat from excessive temperature if the thermostat control should fail. The power light will turn 'Off' if the over temperature control has been triggered. The twin tank fryer (E44E) has an individual 'Fail Safe Over Temperature Safety Cut-Out' for each tank.

Over-Temp Control

The over-temp thermostat is mounted behind the transformer panel, behind the access door and its sensing bulb is located alongside the thermostat.

This control is set for approx. 225-235°C oil cutout temperature. To reset the 'Overtemp Control', allow the oil to cool down to approx 160-180°C then operate the red switch behind the access door. The power light will then turn 'On'.

NOTE: On dual tank models, if either 'Over-Temperature Control' is triggered, a fault exists in the main thermostat and this must be reported and repaired. For temporary operation, the Model E43E is fitted with a thermostat as a backup.

Cleaning and Maintenance

General



Warning

DO NOT USE FLAMMIBLE SOLVENTS AND CLEANING AIDS ON OR IN CLOSE PROXIMITY TO FRYER WHILST FRYER IS STILL HOT.



Caution

Always turn 'Off' electrical supply before cleaning the fryer.

This appliance is not water proof.

Do not use water jet spray to clean interior or exterior of this appliance.

To achieve the best results, cleaning must be regular and thorough and all controls and mechanical parts checked and adjusted periodically by a qualified service person. If any small faults occur, have them attended to promptly. Don't wait until they cause a complete breakdown. It is recommended that the appliance is serviced every 6 months.

Clean the fryer regularly. A clean fryer looks better, will last longer and will perform better.

NOTE:

- **DO NOT use sharp scrapers, strong solvents, abrasive or caustic detergents as they could corrode or damage the fryer.**
- **Ensure that any detergent or cleaning material have been completely removed after each cleaning.**

To keep your fryer clean and operating at peak efficiency, follow the procedures below:-

Draining and Daily Cleaning

1. At end of each day or at end of each shift, if frying schedule is heavy, frying medium should be drained and filtered into a receptacle.



Warning

DO NOT ATTEMPT TO MOVE FRYER WHILST FRYER IS FULL OF OIL.



Caution

**Never drain the fryer with power or elements turned 'ON'
Always switch 'OFF' the fryer before draining or re-filling the tank.**

2. Always filter the fryer when the cool zone under the elements is hot and liquid. A cold fryer heated up won't drain, because frying medium in this zone will remain hard if using solid fat / oils.
3. Screw the drain extension pipe onto the end of the drain valve (see Fig 4) and position a suitable container and filter under the drain extension pipe.

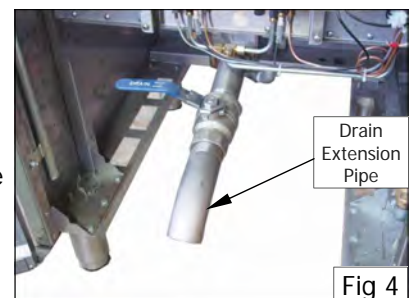

Opening the Drain Valve



Warning

HOT OIL WILL BURN - DO NOT RUSH THIS JOB.

- a. Lift the locking slide on the valve handle (Fig 5) to release valve.
- b. While holding the locking slide in the withdrawn position, rotate the handle anticlockwise (Fig 6) to open the valve.
- c. When valve is closed, the locking slide will drop down over the locking valve to prevent accidental opening of the valve as shown in Fig.5.

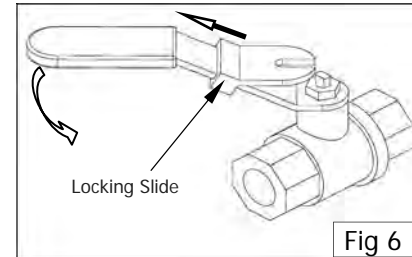
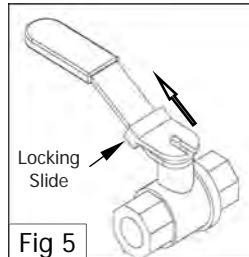

4. Do not empty the total contents of the fryer into one large container, as this will be dangerous and may be difficult, when lifted up, to pour hot oil back into tank.
5. Slip a muslin or other suitable filter bag over the end of the drain valve. Crumbs will be caught in the bag but frying medium will strain freely through into receptacle.
6. Open drain valve slowly to minimise splashing, and take care not to overfill container.
7. When tank has been drained, use a ladle or small pan with a handle and dip into hot frying medium from container and pour around sides and bottom of tank to wash out crumbs and particles adhering to tank.
8. Continue to dip and pour until all crumbs are washed down and into filter bag.
9. Open drain valve fully and check for any particles or crumb residue lodged in the valve. Clean out the valve with a stiff nylon brush. Do not use a wire brush as this may damage the valve seating and will eventually lead to leakage. If obstruction cannot be removed with a soft brush, use a wooden probe to dislodge obstruction.
10. Wipe all exterior panels with a cloth dampened with detergent and rinse off any residue with clean warm water.
11. Clean Control Panel with a damp cloth lightly moistened with a solution of water and a commercial quality foodservice approved detergent.
12. Once the daily cleaning operation is completed, close drain valve and pour frying medium back into the tank.

Cleaning and Maintenance

Weekly Cleaning

NOTE: If fryer usage is very high, we recommend that the weekly cleaning procedure is carried out more frequently.

1. Proceed to drain and filter the tank as for 'Daily Cleaning'. Do not refill tank with frying medium until it has been thoroughly cleaned as shown below.
2. Fill fryer with cold water to the normal fill level and add a high quality commercial cleaner that has been specifically formulated for fryers. *All purpose cleaners are not recommended.*

NOTE: Never use a caustic or lye solution, as this will leave a fat destroying film on tank.

3. Ensure that the elements are lowered into the tank. Switch 'ON' the power and heat the water to approximately 80-90°C.
4. Clean the fryer baskets at the same time by immersing them in the cleaning solution. Allow fryer to soak for 5-10 minutes or as directed on cleaner instructions. Remove baskets and turn **Off** main burners.
5. Scrub the baskets and fryer tank with a stiff nylon bristle brush to remove any remaining deposits. ***DO NOT use a wire brush to clean the tank , as this will scratch the sides of the tank.***
6. Empty fryer and rinse thoroughly with water. Use a 1 part vinegar to 15 parts water solution to rinse tank and neutralise any cleaner residue. If this proves unsuitable for cleaner being used, use a weaker solution of up to 1 part vinegar to 25 parts water.
7. Rinse tank thoroughly with water, drain and dry.
8. Refill tank with new filtered frying medium.

Stainless Steel Surfaces

- a. With the tank(s) drained, cleaned and dried as shown above, clean exterior surfaces of the fryer with hot water, a mild detergent solution and a soft cloth.
- b. Dry all components thoroughly with a dry cloth and polish with a soft dry cloth.
- c. To remove any discoloration, use an approved stainless steel cleaner or stainless steel wool. Always rub in direction of the grain.

Periodic Maintenance

NOTE: All maintenance operations should only be carried out by a qualified service person.

To achieve the best results, cleaning must be regular and thorough. All controls and mechanical parts should be checked and adjusted periodically by a qualified service person. If any small faults occur, have them attended to promptly. Don't wait until they cause a complete breakdown. It is recommended that the appliance is serviced every 6 months.

Guide to Cooking Problems with Fryer

This section provides an easy reference guide to the more common problems that may occur during the operation of your equipment. The fault finding guide in this section is intended to help you correct, or at least accurately diagnose problems with your equipment.

Although this section covers the most common problems reported, you may encounter a problem not covered in this section. In such instances, please contact your local authorised service agent who will make every effort to help you identify and resolve the problem. Please note that the service agent will require the following information:-

- **Model Code and Serial Number of appliance. (both can be found on Rating Plate located on the appliance).**

Fault	Possible Cause	Remedy
Frying Medium Foaming.	Presence of soap or detergent residue from cleaning the tank.	Rinse fryer thoroughly three times with clean water. Ensure fryer is perfectly dry before re-filling with frying medium.
	Excessive breakdown of frying medium.	Add fresh frying medium daily to replace contents every 3-5 days.
	Continual frying of food with excess moisture.	Remove excess moisture from foods to be fried.
	Continued overheating of oil.	Check thermostat setting. Turn down heat to around 120°C (Standby) when use is quiet.
	Overloading.	Maintain 1-8 ratio of food to frying medium.
Gumming.	Heating frying medium too rapidly.	When charging fryer or starting up, melt frying medium gradually.
	Continued overheating of the frying medium.	Check thermostat setting with a thermometer or thermocouple.
	Frying oil broken down.	Check amount of fresh frying medium added to fryer to be sure 'turnover' is adequate.
	Using wrong cooking frying medium.	Some frying mediums form gums when used in a deep fryer. e.g safflower oil.
Greasy Foods.	Frying at too low temperatures.	Increase temperature and check thermostat setting.
	Inadequate preparation of food.	Be sure foods (especially potatoes) are 'cured' correctly.
	Excessive quantities of breading or batter.	Remove surplus breading or batter.
	Placing food in frying medium direct from the freezer.	Allow frozen foods to thaw before frying.
	Surplus moisture in and on surface of food.	Drain and dry foods before frying.
	Frying medium in advanced stages of breakdown.	Discard 'old' frying medium and refill fryer with new frying medium.
	Use of dripping or other unrefined oil.	Due to low smoking point, cooking in these oils at lower temperatures will result in greater oil absorption by the food.
	Using the wrong kind of cooking oil.	Always use a completely refined and deodorised cooking oil.
Rapid Oil Breakdown.	Inadequate frying oil turnover.	Adjust procedures to fry more food in fryer to increase turnover.
	Overheating of oil.	Check thermostat setting with a thermometer or thermocouple.
	Contamination.	Filter or strain the oil daily.
	Poor cleaning procedures.	Clean fryer daily or at least once a week and rinse thoroughly. Dry fryer before use.
	Presence of copper or brass in the fryer equipment.	Remove all copper or brass fittings from contact with the oil.
	Overloading fryer.	Maintain 1-8 ratio of food to frying oil.
	Food excessively moist.	Drain and dry the food before frying.
	Overheating oil on 'Standby' mode.	Reduce temperature of frying oil between 93°C during idle ('Standby') periods.

Fault Finding

Fault	Possible Cause	Remedy
Oil Smoking.	Insufficient turnover of oil.	Maintain a minimum quantity of oil in fryer for more rapid turnover or increase the quantity of food fried in fryer. Replace with fresh oil every 3 to 5 days.
	Continual frying with excess moisture on food.	Drain foods before frying, pat food dry.
	Contamination of oil.	Filter or strain daily to remove contaminants.
	Overheating of oil.	Check thermostat setting with a thermometer or thermocouple.
	Rapid breakdown of oil.	Use a stable frying oil.
	Use of unrefined oils.	Dripping smokes at lower temperature than refined and deodorised oils.
Darkening of Oil.	Presence of salt on the food.	Salt foods after frying and away from the fryer.
	Foods dipped in batter high in egg yolk.	Reduce egg content of batter, replace part egg with milk.
	Contamination of oil.	Filter or strain oil daily to remove contaminants.
	Poor cleaning practice.	Clean fryer at least weekly or each day in cases of heavy usage. Ensure fryer is perfectly dry before use.
	Overheating of oil.	Check thermostat setting with a thermometer or thermocouple.
	Insufficient oil turnover.	Top up daily to replace the contents of fryer in 3 to 5 days.
	Cooking foods with high sugar levels.	At the end of the season, potatoes are usually high in reduced sugars. When fried, they will darken quickly and colour the oil.

NOTE: Excessive oil usage is an indication of high absorption of oil into the food. This is a function of temperature and character of the goods being fried - NOT due to type of oil being used (unless refined oils are being used). Any variation in the apparent life of the oil is always due to one or more of the causes mentioned above.

Fault Finding the Electrical System

Fault	Possible Cause	Remedy
Elements do not Heat Up.	<p>Check mains power is supplied to the unit and that a circuit breaker or fuse has not tripped / blown.</p> <p>Check element is flat and that the tilt microswitch is closed.</p> <p>Check thermostat setting is correct and that control knob is set to 'ON' position.</p>	<p>Turn On power. Reset circuit breaker or replace blown fuse.</p> <p>Adjust microswitch so that the microswitch is activated when element is fully down in the flat (cooking position).</p> <p>Replace thermostat. Call service provider.</p>
Over-Temperature Thermostat Cuts Out.	<p>Over-temperature thermostat faulty.</p> <p>Control thermostat not maintaining set temperature.</p> <p>a. Thermostat out of calibration. b. Thermostat does not open on temperature rise.</p> <p>Thermostat opens on temperature rise but control valve does not respond.</p>	<p>If the overtemp cuts out below 220°C, replace over-temperature thermostat.</p> <p>Check continuity through thermostat leads, on temperature rise. If circuit does not open, replace thermostat.</p> <p>Check electrical connections are correct. Call service provider.</p>

Wiring Schematics

E43 Single Tank

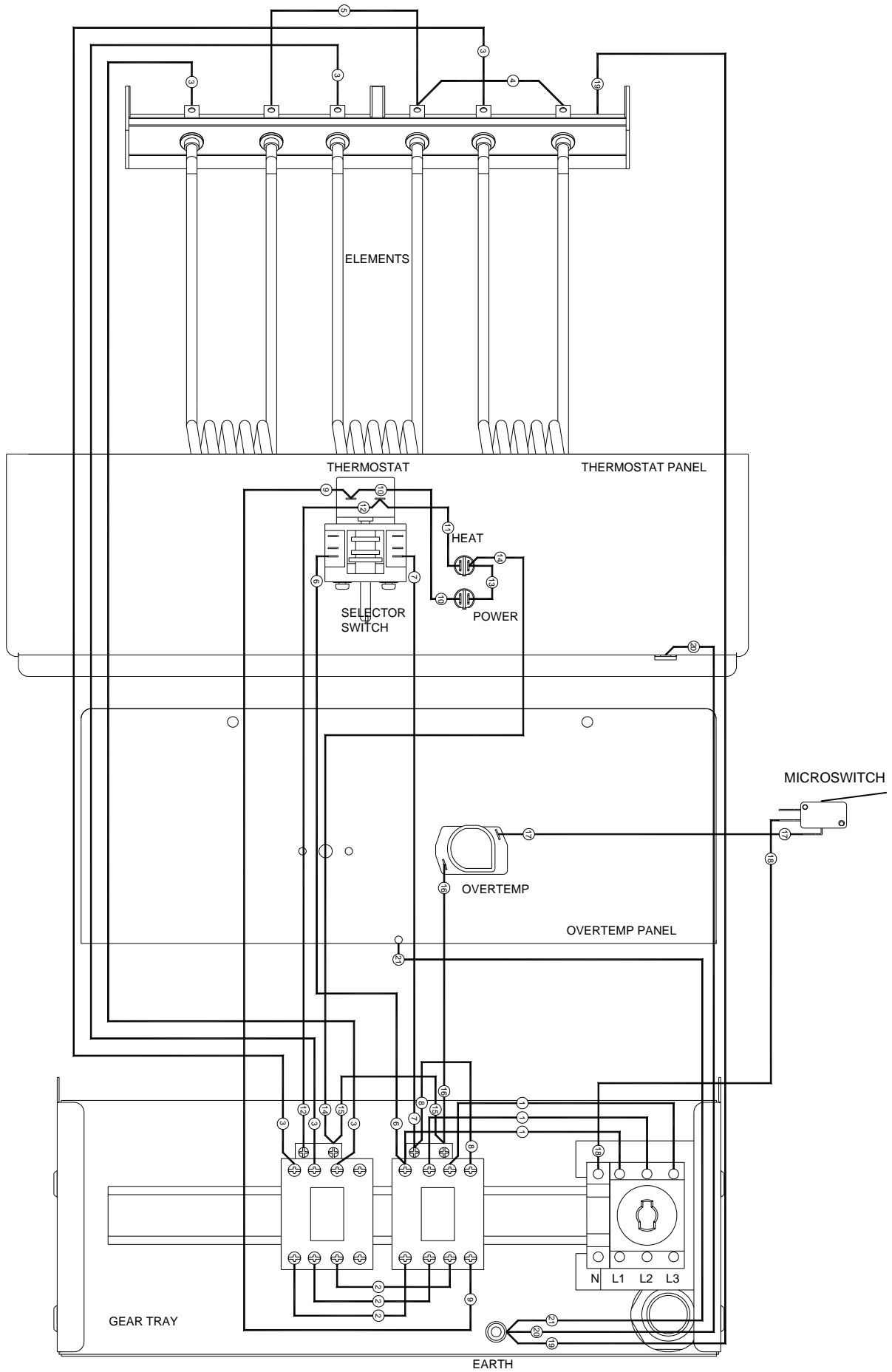

E44 Twin Tank

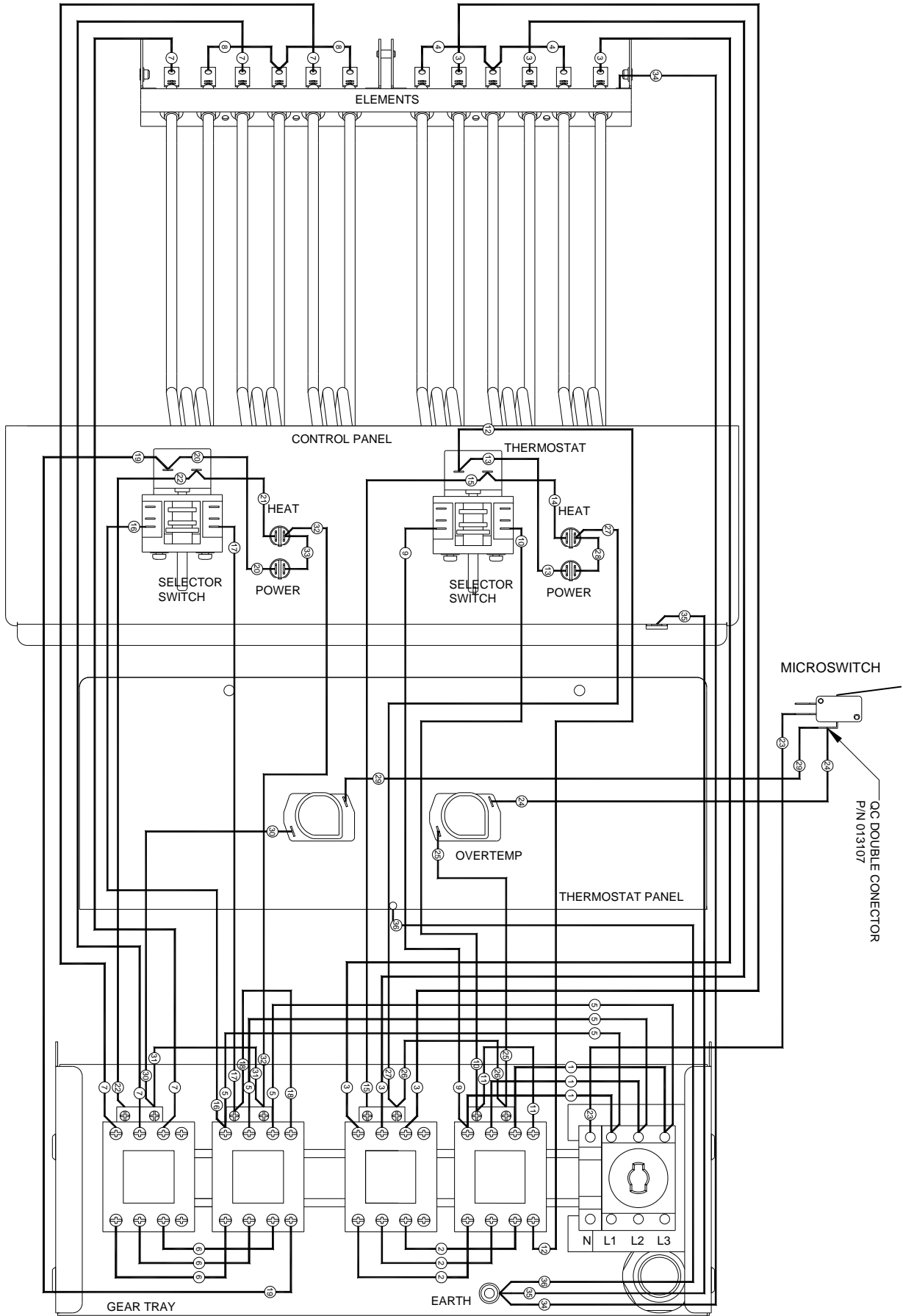

Wiring Schematics

E43E Single Tank

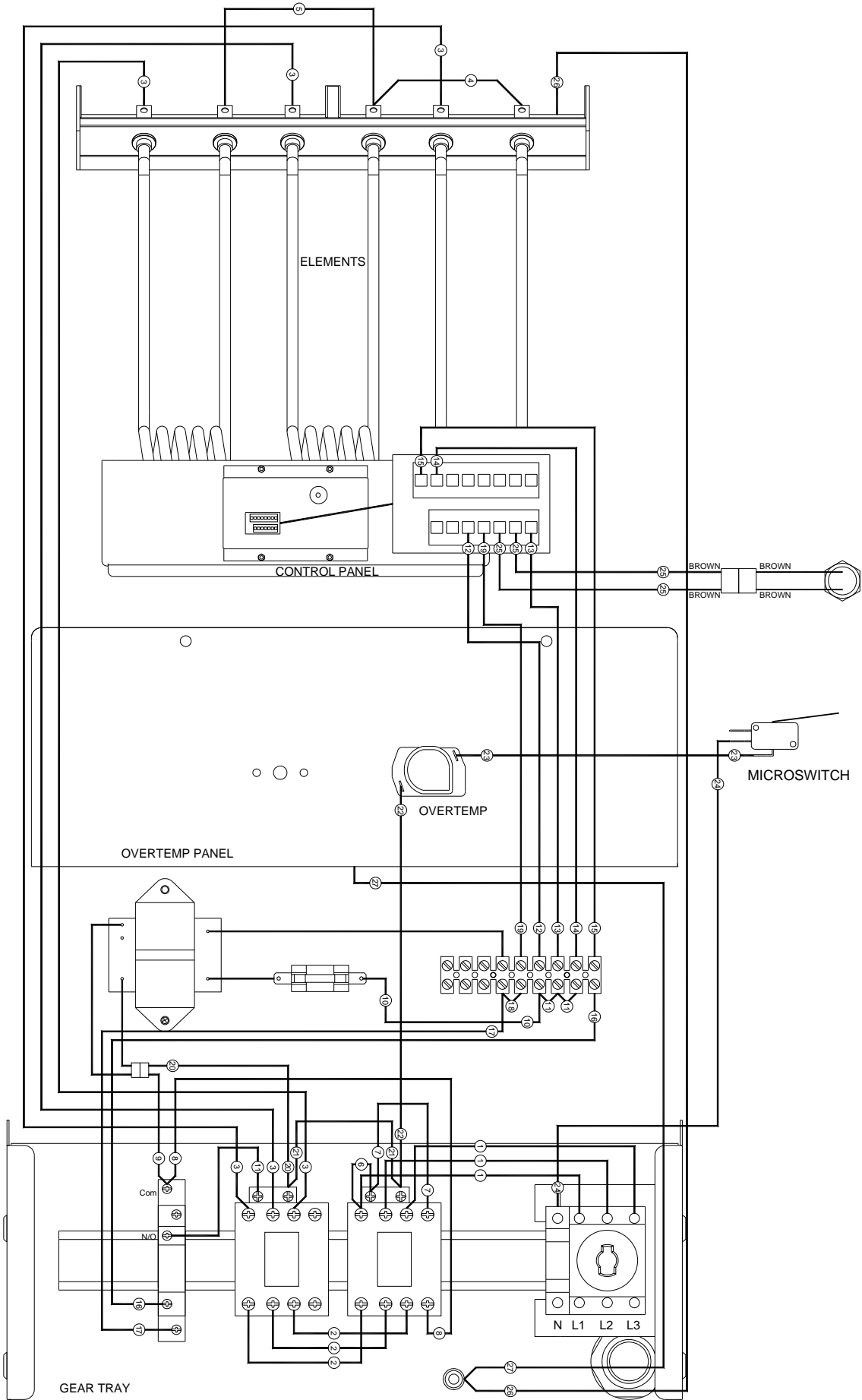

E44E Twin Tank

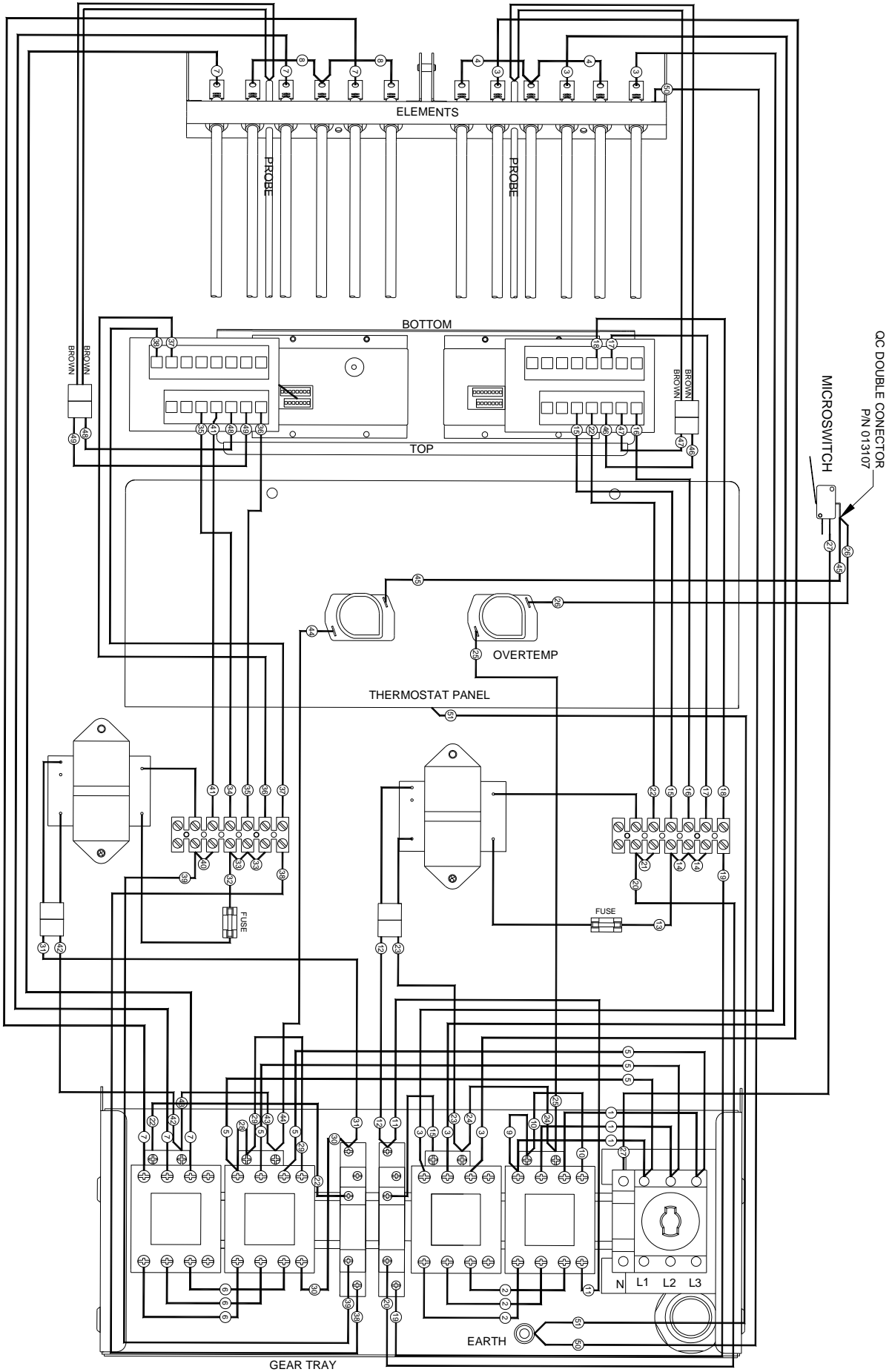

Controller Advanced Programming Mode

The following Parameters can be accessed and adjusted in the Advanced Programming Mode:-

- Timing Mode (Straight or Flexi cook time).
- Temperature Offset (Calibration Setting) -14° to $+14^{\circ}$.
- Temperature Display Mode (Temp display or prompt display).
- Programming the Melt Cycle.
- Setting the Temperature Units (either $^{\circ}\text{C}$ or $^{\circ}\text{F}$).
- System Programmable Default Settings.

1. Press the 'ON / OFF' Key to turn 'ON' the fryer controller.
2. Press Programme Key 'P' and 'Timer 1' Key together to enter 'Advanced Programming Mode'.
3. **If 'LoC' is displayed**, password protection is turned 'ON' and control panel is locked. Unlock the control panel, refer to 'Controller Basic Programming Mode' - 'Entering the Controller Basic Settings', and repeat from Item 2 above.

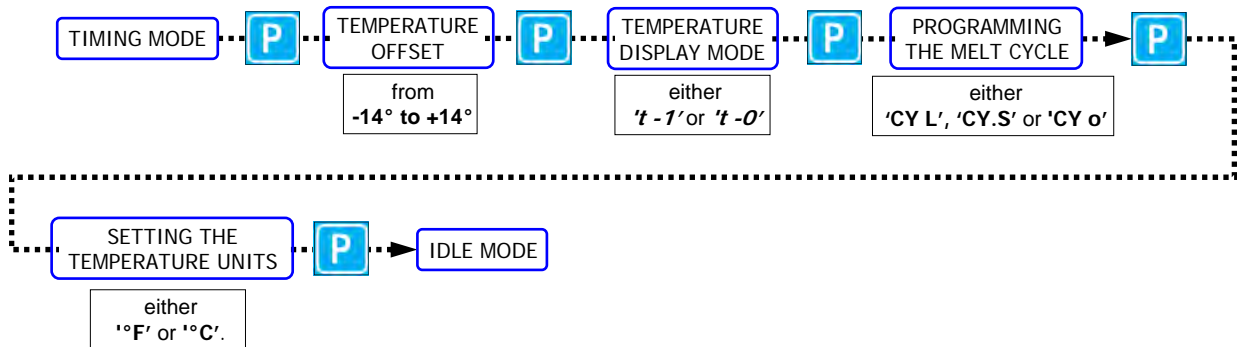
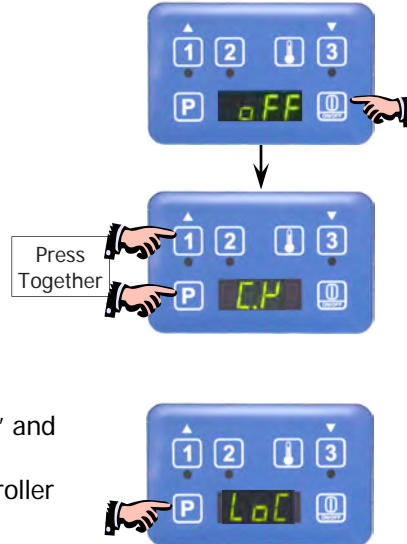

Timing Mode

1. One of the following options will display:-

Straight Cook Time

Straight cook time refers to real time cooking.

Flexible Cook Time

Cook time can be automatically adjusted to compensate for size of load being cooked.

2. To change 'Timing Mode', press either 'Timer 1' or 'Timer 3' Key.
3. Press Program 'P' Key to confirm options, the change will be accepted and display will step on to 'Temperature Offset' parameter.

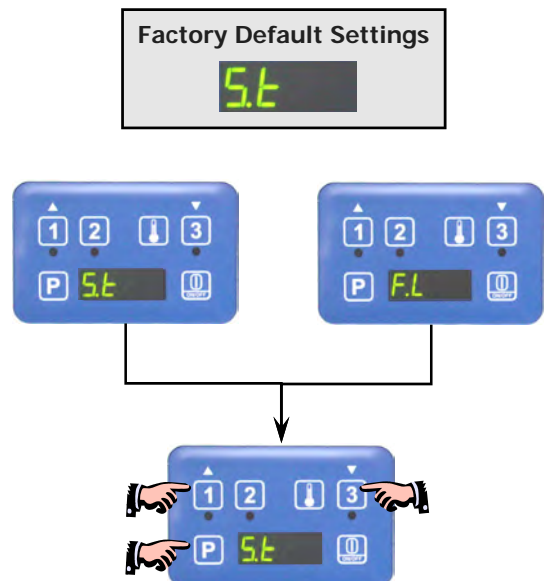

Controller Advanced Programming Mode

Temperature Offset

The display temperature can be adjusted by between -14° to +14°.

Factory Default Settings

0°

To Calibrate the Control Temperature

- Set control temperature to 170°.
- Measure the oil temperature that the control is cycling at.
- If oil temperature is **higher** than the reading shown on the control panel, enter a **positive** value of the difference between the oil temperature and the set temperature (170° + difference).
- If oil temperature is **lower** than the reading shown on the control panel, enter a **negative** value of the difference between the oil temperature and the set temperature (170° - difference).

1. Temperature offset will appear on the screen.
2. To change temperature offset option, press either 'Timer 1' or 'Timer 3' Key to change selection.
3. Press Program Key 'P' to confirm the change and the display will step on to '**Temperature Display**' parameter.



Temperature Display Mode

Factory Default Settings

t. -0

Temperature display can be set for either of two display modes:-

't - 1' - Display will show oil temperature as an actual temperature.

't - 0' - Display will show one of the following temperature status;

'HEAt' - Awaiting for fryer to heat up to set temperature.



'droP' - When fryer is within 10° of set temperature to indicate that fryer is ready for loading.



1. One of the following options will display:-
2. Press either 'Timer 1' or 'Timer 3' Key to select option required.
3. Press Program Key 'P' to accept the change and display will step on to the '**Programming the Melt Cycle**' parameter.

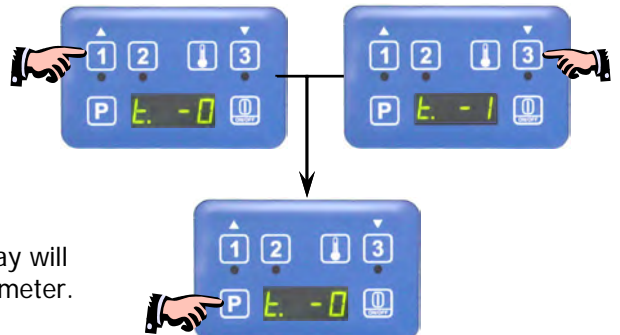

Controller Advanced Programming Mode

Programming the 'Melt Cycle'.

1. One of the following 3 options may be selected:-

- 'L' (Liquid).
- 'S' (Solid).
- 'O' (Override).

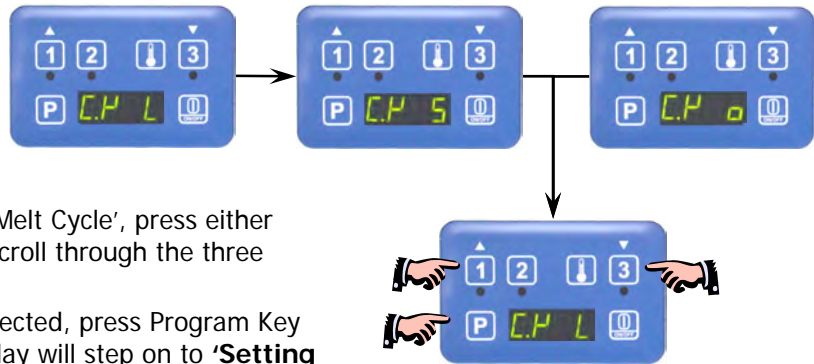

2. To change the programmed 'Melt Cycle', press either 'Timer 1' or 'Timer 3' Key to scroll through the three options.
3. Once the desired option is selected, press Program Key 'P' to accept the change, display will step on to **'Setting the Temperature Units'**.

Setting the 'Temperature Units'.

1. User may select from 'F' (Fahrenheit) or 'C' (Celsius).
2. Press either 'Timer 1' or 'Timer 3' Key to change selection.
3. Press Programme 'P' Key, the change will be accepted and display will revert to **'Idle Mode'**.

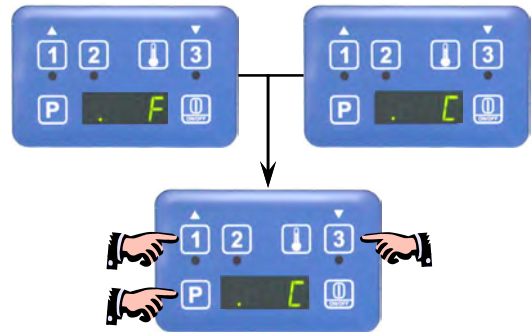

NOTE:

- Pressing and holding Programme 'P' Key for approximately 3 seconds (Or not pressing any keys for 2 minutes) during Advanced Programming Mode, the appliance will exit Advanced Programming Mode and return to Idle Mode.

System Programmable Default Settings

The table below shows a list of the programmable parameters and the default settings for this appliance. These settings can be edited from the Control Panel when in either **'Controller Basic Programme Mode'** or **'Controller Advanced Programming Mode'**.

Programmable Default Settings	
Controller Basic Programming Mode	Default Settings
Timer 1 'L' Cook Time	3:00 min.
Timer 2 'Ctr' Cook Time	3:00 min.
Timer 3 'R' Cook Time	3:00 min.
Temperature Set Point	177°C (350°F).
Keypad Lock or Unlock	Unlock.
Controller Advanced Programming Mode	Default Settings
Timing Mode	S.t (Straight).
Temperature Offset	0°.
Temperature Display Mode	t. -0 = 'HEAT' or 'droP'.
Melt Cycle Mode	L (Liquid).
Degrees; °F or °C	°C.

Replacement Parts List

IMPORTANT:

Only genuine authorized replacement parts should be used for servicing and repair of this appliance. Instructions supplied with parts should be followed when replacing components.

For further information and servicing instructions, contact your nearest authorized service branch (contact details are as shown on reverse of front cover of this manual).

When ordering replacement parts, please quote the part number and description as listed below. If the part required is not listed below, request the part by description and quote the Model and Serial Number which is shown on the rating plate.

Part No	Description	E43	E44	E43E	E44E
228922	Neon (Clear)	1	2		
227963	Neon (Orange)	1	2		
227389	Knob 6mm 60-200°C	1	2		
228375	Switch Actuator ON / OFF	1	1	1	1
228374	Load Switch ON / OFF	1	1	1	1
024018	Overtemp Thermostat	1	2	1	2
020256	Reset Relay 24V AC			1	2
011982	Thermostat 60°C - 200°C	1	2		
229355	Selector Switch	1	2		
024802	Door Microswitch	1	1	1	1
013977	Door Microswitch Insulator	1	1	1	1
014612	Fryer Element (Single Tank)	3		3	
015299	Fryer Element (Double Tank)		6		6
017717	Temperature Probe			1	2
228660	Transformer 24Vac			1	2
229033	Fuse Holder			1	2
020109	Fuse 2 Amp			1	2
228707	Digital Controller			1	2
230101	Controller Overlay (3 Basket / Timer)			1	2
231739	Contactors	2	4	2	4
025948	Terminal Block - 6 Way			1	2
General					
018019	Basket (Standard).	3	3	3	3
227856	Door Magnetic Catch.	1	1	1	1
227449	Door Handle	1	1	1	1
018358	Drain Valve.	1		1	
019390	Drain Valve.		2		2
021885	Drain Extension.	1		1	
021932	Drain Extension.		1		1
228761	Fryer Lid.	1	1	1	1
015279	Lid Handle (Black)	1	1	1	1
227850	Leg Adjustable - 150mm	2	2	2	2
229674	Rear Roller Assy	2	2	2	2
Accessories					
228793	Plinth Kit - 450mm (Fryer).				

