



Adjustable thermostat for accurate temperature maintenance

Powerful fan for even circulation of cold air

Metal door frame for durability and reliability (display units only)

Large illuminated display for maximum impact

Self-closing doors minimise temperature loss

Double-glazed (Fridges) or triple-glazed (freezers) safety glass doors increase energy efficiency

High-density polyurethane insulation keeps temperature and energy consumption low

Adjustable shelving for flexibility in display configuration (excluding static freezers)

High-impact internal lighting for perfect product presentation

Lockable castors make movement and placement easy

Bromic's Vertical Display & Storage range offers complete versatility, available in one-, two- and three-door configurations across a wide range of temperatures and styles.

13. Upright Display Fridges & Freezers

Bromic's Upright Display Fridges and Freezers offer reliability in a stylish casing, creating display solutions suited to self-service retail applications.

These dependable units achieve exceptional efficiency while maintaining longevity through simplicity.



16. LCD Video Fridge

Bromic's LCD Video Fridge introduces exciting movement to point-of-sale marketing, demanding the attention of customers by overlaying refrigerated products with relevant advertisements or imaginative entertainment.

This unit's 50-inch LG Ultra High Contrast LCD display resides within a double-glazed door and is able to switch rapidly between transparency and video content without sacrificing quality in bright environments.



21. Upright Storage Fridges & Freezer

Bromic's Upright Storage Fridges and Freezers prioritise reliability through simplicity to create an affordable storage solution.

This unit's corrosion-resistant outer casing is insulated on all four sides to minimise energy consumption by allowing the refrigeration system to operate efficiently only when it is needed.



23. Fan-Forced Upright Display Fridges & Freezers

Bromic's Fan-Forced Upright Display Fridges and Freezers are packed full of premium perks to ensure perfect performance in high-volume, self-service retail applications.

Defrosting and temperature are automatically regulated by the unit's digital controller while fast fan-forced cooling, heated glass doors and ambient ratings combine to keep products primed even in the harshest of Australian conditions.



25. Specification Reference Guide

VERTICAL DISPLAY & STORAGE

Vertical Display & Storage

Upright Display Fridges

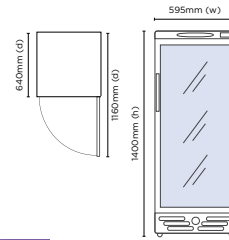

GM0220 LED ECO



Flat Glass Door 215L LED Display Fridge

Part No.	Capacity	Weight
3736033	215L	68kg

	External (mm)	Internal (mm)
Width	595	505
Depth	640	462
Height	1400	1025

- High-impact LED lighting maximises product visibility and captures attention
- Double-glazed safety glass increases efficiency while reducing condensation
- Self-closing door for hassle-free self service
- Temperature range: +1°C to +10°C

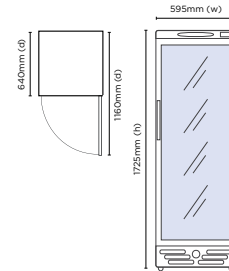

GM0300 LED ECO



Flat Glass Door 290L LED Display Fridge

Part No.	Capacity	Weight
3736034	290L	74kg

	External (mm)	Internal (mm)
Width	595	505
Depth	640	462
Height	1725	1355

- High-impact LED lighting maximises product visibility and captures attention
- Double-glazed safety glass increases efficiency while reducing condensation
- Self-closing door for hassle-free self service
- Temperature range: +1°C to +10°C

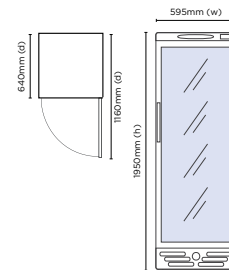

GM0374 LED ECO



Flat Glass Door 372L LED Display Fridge

Part No.	Capacity	Weight
3736035	372L	81kg

	External (mm)	Internal (mm)
Width	595	505
Depth	640	462
Height	1950	1555

- High-impact LED lighting maximises product visibility and captures attention
- Double-glazed safety glass increases efficiency while reducing condensation
- Self-closing door for hassle-free self service
- Temperature range: +1°C to +10°C

Vertical Display & Storage

Upright Display Fridges

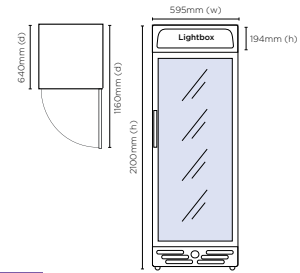

GM0374L LED ECO



Flat Glass Door 372L LED Display Fridge

Part No.	Capacity	Weight
3736036	372L	85kg

	External (mm)	Internal (mm)
Width	595	505
Depth	640	462
Height	2100	1555

- High-impact LED lighting and customizable lightbox capture attention
- Double-glazed safety glass increases efficiency while reducing condensation
- Self-closing door for hassle-free self service
- Temperature range: +1°C to +10°C

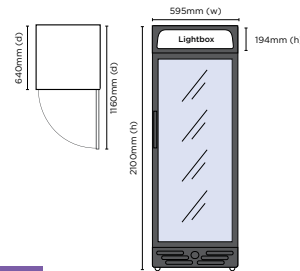

GM0374LB LED



Flat Glass Door 372L LED Display Fridge

Part No.	Capacity	Weight
3736092	372L	85kg

	External (mm)	Internal (mm)
Width	595	505
Depth	640	462
Height	2100	1555

- High-impact LED lighting and customizable lightbox capture attention
- Double-glazed safety glass increases efficiency while reducing condensation
- Self-closing door for hassle-free self service
- Temperature range: +1°C to +10°C

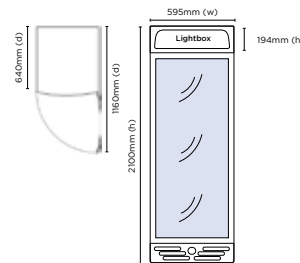

GM0400LC LED



Curved Glass Door 380L LED Display Fridge

Part No.	Capacity	Weight
3736037	380L	90kg

	External (mm)	Internal (mm)
Width	595	505
Depth	640	462
Height	2100	1555

- High-impact LED lighting and customizable lightbox capture attention
- Double-glazed safety glass increases efficiency while reducing condensation
- Self-closing door for hassle-free self service
- Temperature range: +1°C to +10°C

Vertical Display & Storage

Upright Display Fridges

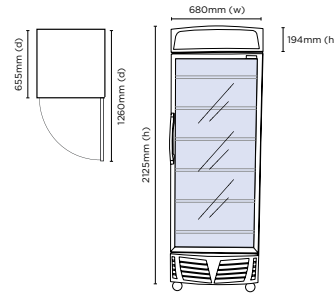

GM0440L LED



Flat Glass Door 438L LED Display Fridge

Part No.	Capacity	Weight
3736038	438L	110kg

	External (mm)	Internal (mm)
Width	680	580
Depth	655	495
Height	2125	1515

- High-impact LED lighting and customizable lightbox capture attention
- Double-glazed safety glass increases efficiency while reducing condensation
- Self-closing door for hassle-free self service
- Temperature range: +1°C to +10°C

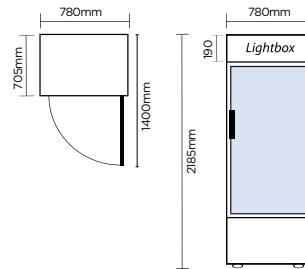

GM0690LW LED



Flat Glass Door 690L LED Display Fridge

Part No.	Capacity	Weight
3736219	659L	123kg

	External (mm)	Internal (mm)
Width	780	702
Depth	705	555
Height	2185	1682

- 43°C ambient temperature rating
- Double glazed Low-E glass doors reduce energy consumption and condensation
- High-impact internal lighting for superior product presentation
- Adjustable shelving for flexibility
- Illuminated light box to highlight branding
- Temperature range: +1°C to +5°C



FF

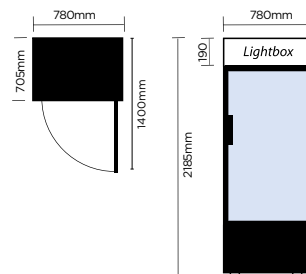

GM0690LB LED



Flat Glass Door 690L LED Display Fridge

Part No.	Capacity	Weight
3736222	659L	123kg

	External (mm)	Internal (mm)
Width	780	702
Depth	705	555
Height	2185	1682

- 43°C ambient temperature rating
- Double glazed Low-E glass doors reduce energy consumption and condensation
- High-impact internal lighting for superior product presentation
- Adjustable shelving for flexibility
- Illuminated light box to highlight branding
- Temperature range: +1°C to +5°C



FF

Vertical Display & Storage

Upright Display Fridges

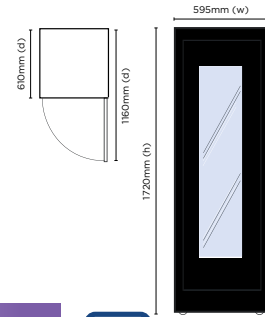

GMO300 RETRO

SPECIAL ORDER

1 YEAR EXTRA CARE WARRANTY SERVICE

Retro 290L LED Display Fridge

Part No.	Capacity	Weight
3736079	290L	85kg
External (mm)		Internal (mm)
Width	595	505
Depth	610	462
Height	1720	1555

- Front glass panel with green LED surround embedded into door glass
- Completely customisable 1950s-inspired retro unit that allows endless creative freedom*
- Temperature range: +1°C to +10°C

*Minimum quantity required



Wine Fridge

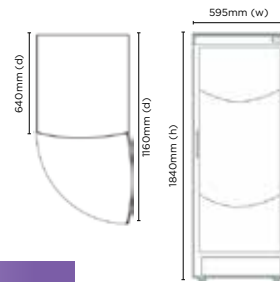

WC0400C LED ECO

1 YEAR EXTRA CARE WARRANTY SERVICE

Curved Glass Door 372L Wine Fridge

Part No.	Capacity	Weight
3735145	372L	84kg
External (mm)		Internal (mm)
Width	595	505
Depth	640	462
Height	1840	1555

- Reversible doors for complete flexibility
- 5 adjustable wooden shelves hold up to 50 bottles of wine
- Lockable castors make movement and placement easy
- Analogue controller with digital display for precise temperature maintenance
- Temperature range: +1°C to +18°C

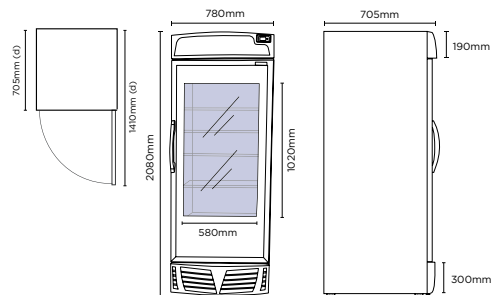

GMO690-VID

SPECIAL ORDER

1 YEAR EXTRA CARE WARRANTY SERVICE

LCD Video 657L Display Fridge

Part No.	Capacity	Weight
3736093	657L	136kg
External (mm)		Internal (mm)
Width	780	555
Depth	705	702
Height	2080	1682

- 50-inch LG Ultra-High Contrast LCD display
- 1080 x 1920 screen resolution with a super wide 178° viewing angle
- Self-closing door with stay for easy stocking and hassle-free self service
- Environmentally friendly R600 refrigerant
- Temperature range: +1°C to +10°C

Vertical Display & Storage

Upright Display Fridges

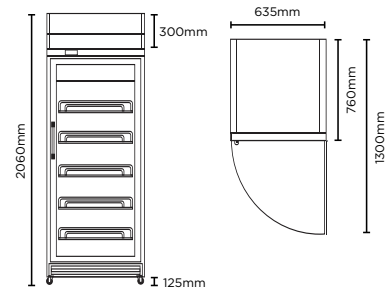

GD0500LF



Flat Glass Door 444L LED Display Fridges

Part No.	Capacity	Weight
3736245	444L	95kg

	External (mm)	Internal (mm)
Width	635	520
Depth	760	550
Height	2060	1420

- Double-glazed heated safety glass increases efficiency while reducing condensation
- Self-closing door with stay for easy stocking and hassle-free self service
- Temperature range: +2°C to +8°C

FF

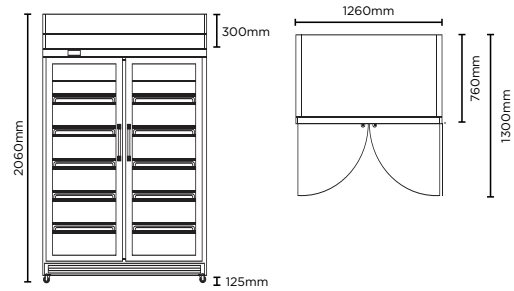

GD1000LF



Flat Glass Door 976L LED Display Fridges

Part No.	Capacity	Weight
3736246	976L	157kg

	External (mm)	Internal (mm)
Width	1260	1143
Depth	760	550
Height	2060	1420

- Double-glazed heated safety glass increases efficiency while reducing condensation
- Self-closing door with stay for easy stocking and hassle-free self service
- Temperature range: +2°C to +8°C

FF

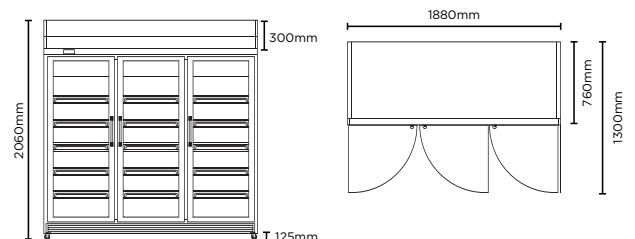

GD1500LF



Flat Glass Door 1507L LED Display Fridges

Part No.	Capacity	Weight
3736247	1507L	209kg

	External (mm)	Internal (mm)
Width	1880	1755
Depth	760	550
Height	2060	1420

- Double-glazed heated safety glass increases efficiency while reducing condensation
- Self-closing door with stay for easy stocking and hassle-free self service
- Temperature range: +2°C to +8°C

FF

Vertical Display & Storage

Upright Display Fridges

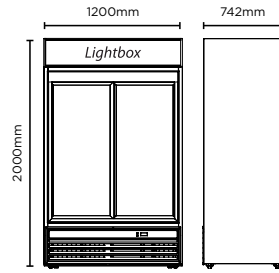

GM0980LS LED



Sliding Glass Door 945L LED Display Fridge

Part No.	Capacity	Weight
3735048	945L	210kg

- High-impact LED lighting and customizable lightbox capture attention
- Double-glazed safety glass increases efficiency while reducing condensation
- Self-closing door for hassle-free self service
- Illuminated light box to highlight branding
- Temperature range: +1°C to +10°C

	External (mm)	Internal (mm)
Width	1200	1090
Depth	742	572
Height	2000	1533

FF

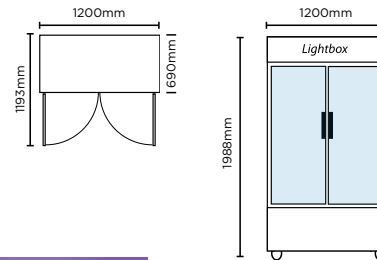

GM1000LW ECO



Flat Glass Door 960L LED Eco Beverage Display Fridge

Part No.	Capacity	Weight
3736252	960L	177kg

- Double-glazed heated safety glass increases efficiency while reducing condensation
- Adjustable shelving for flexibility in display configuration
- High-impact LED internal lighting
- Illuminated light box to highlight branding
- Temperature range: +1°C to +10°C

	External (mm)	Internal (mm)
Width	1200	1090
Depth	690	545
Height	1998	1707

FF

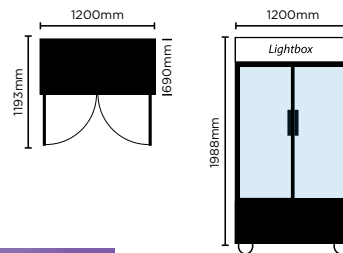

GM1000LB ECO



Flat Glass Door 960L LED Eco Beverage Display Fridge

Part No.	Capacity	Weight
3736253	960L	177kg

- Double-glazed heated safety glass increases efficiency while reducing condensation
- Adjustable shelving for flexibility in display configuration
- High-impact LED internal lighting
- Illuminated light box to highlight branding
- Temperature range: +1°C to +10°C

	External (mm)	Internal (mm)
Width	1200	1090
Depth	690	545
Height	1998	1707

FF



Vertical Display & Storage

Upright Display Fridges

REMOVABLE CASSETTE

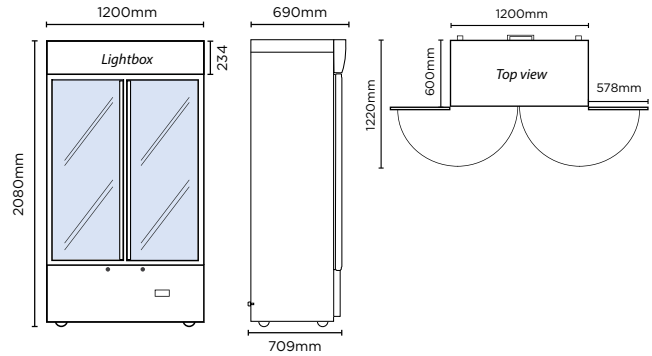

GM1000LBCAS

2 YEAR
EXTRA CARE
WARRANTY SERVICE

Cassette Flat Glass Door 960L LED Display Fridge

Part No. 3736251 Capacity 960L Weight 188kg

	External (mm)	Internal (mm)
Width	1200	1090
Depth	690	545
Height	2080	1465

- High-impact LED internal lighting on each side for perfect product presentation
- Heated air over door prevents condensation
- Fan forced for even temperature throughout the fridge
- Adjustable stabilising floor raisers
- Removable cassette refrigeration
- Temperature range: +2°C to +5°C

Green Cooling™

FF

REMOVABLE CASSETTE

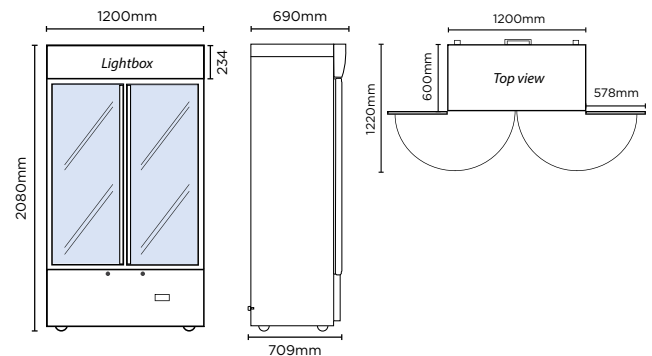

GM1000LWCAS

2 YEAR
EXTRA CARE
WARRANTY SERVICE

Cassette Flat Glass Door 960L LED Display Fridge

Part No. 3736250 Capacity 960L Weight 188kg

	External (mm)	Internal (mm)
Width	1200	1090
Depth	690	545
Height	2080	1465

- High-impact LED internal lighting on each side for perfect product presentation
- Heated air over door prevents condensation
- Fan forced for even temperature throughout the fridge
- Adjustable stabilising floor raisers
- Aluminium door frame
- Temperature range: +2°C to +5°C

Green Cooling™

FF

Vertical Display & Storage



“

Whether you need refrigeration to store products or display your merchandise, there is a Bromic solution for you.

”

Vertical Display & Storage

Upright Storage Fridges

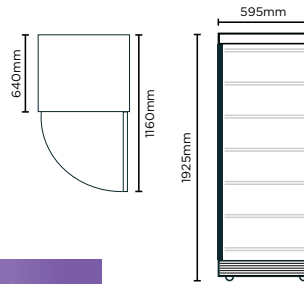

UC0374SDW



Solid Door 372L Storage Fridge

Part No.	Capacity	Weight
3735127	372L	88kg

	External (mm)	Internal (mm)
Width	595	505
Depth	640	462
Height	1925	1555

- Solid insulated coated steel door minimises heat ingress
- Reversible doors for complete flexibility
- Flexible storage with 6 adjustable shelves
- Temperature range: +1°C to +10°C

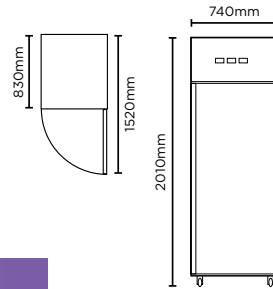

UC0650SD



Gastronom Stainless Steel 650L Storage Fridge

Part No.	Capacity	Weight
3735161	650L	143kg

	External (mm)	Internal (mm)
Width	740	624
Depth	830	685
Height	2010	1390

- Front lockable castors make movement and placement easy.
- Self-closing door provides hassle-free operation and energy efficiency.
- Supplied with stainless steel rails and 5 shelves for use with 2/1 Gastronom trays
- Dixell digital controller for precise temperature maintenance
- Temperature range: +2°C to +8°C

FF

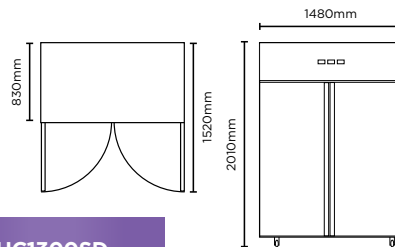

UC1300SD



Gastronom Stainless Steel 1300L Storage Fridge

Part No.	Capacity	Weight
3735200	1300L	213kg

	External (mm)	Internal (mm)
Width	1480	1360
Depth	830	685
Height	2010	1390

- Front lockable castors make movement and placement easy
- Self-closing door provides hassle-free operation and energy efficiency
- Supplied with stainless steel rails and 10 shelves for use with 2/1 Gastronom trays
- Dixell digital controller for precise temperature maintenance
- Temperature range: +2°C to +8°C

FF

Vertical Display & Storage

Upright Display Freezers

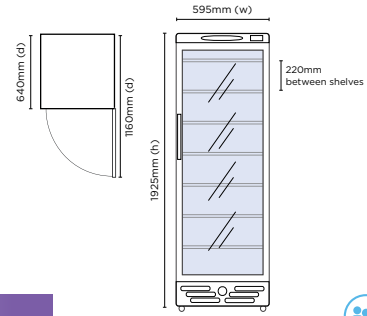

UF0374S LED



Flat Glass Door 300L LED Display Freezer

Part No.	Capacity	Weight
3736045	300L	102kg
	External (mm)	Internal (mm)
Width	595	475
Depth	640	440
Height	1925	1550

- High-impact LED lighting maximises product visibility and captures attention
- Self-closing door for hassle-free self service
- Refrigeration integrated into all 6 fixed shelves for even cooling
- Temperature range: -19°C to -14°C

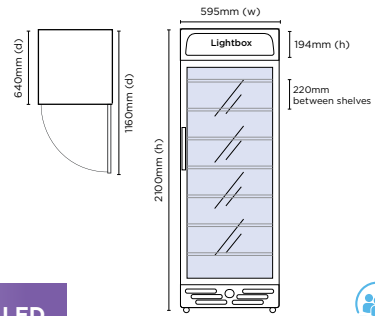

UF0374LS LED



Flat Glass Door 300L LED Display Freezer

Part No.	Capacity	Weight
3736046	300L	106kg
	External (mm)	Internal (mm)
Width	595	475
Depth	640	440
Height	2100	1550

- High-impact LED lighting and customizable lightbox capture attention
- Self-closing door for hassle-free self service
- Refrigeration integrated into all 6 fixed shelves for even cooling
- Temperature range: -19°C to -14°C

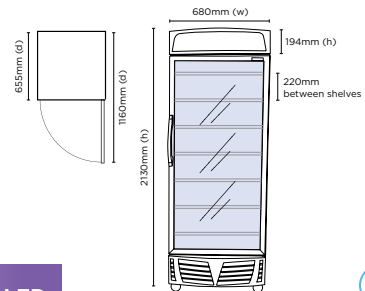

UF0440LS LED



Flat Glass Door 440L LED Display Freezer

Part No.	Capacity	Weight
3736047	440L	123kg
	External (mm)	Internal (mm)
Width	680	577
Depth	655	495
Height	2133	1510

- High-impact LED lighting and customizable lightbox capture attention
- Self-closing door for hassle-free self service
- Refrigeration integrated into all 6 fixed shelves for even cooling
- Temperature range: -19°C to -14°C

Vertical Display & Storage

Upright Display Freezers

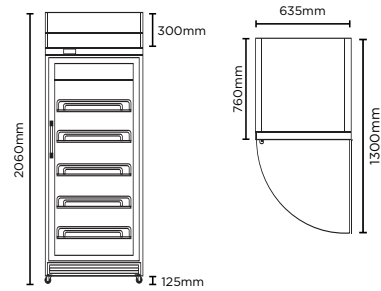

UF0500LF



Flat Glass Door 444L LED Display Freezer

Part No. 3736240 **Capacity** 444L **Weight** 113kg

	External (mm)	Internal (mm)
Width	635	520
Depth	760	550
Height	2060	1420

- Fan-forced refrigeration system
- Triple-glazed heated safety glass increases efficiency while reducing condensation
- Self-closing door with stay for easy stocking and hassle-free self service
- Temperature range: -22°C to -18°C

FF

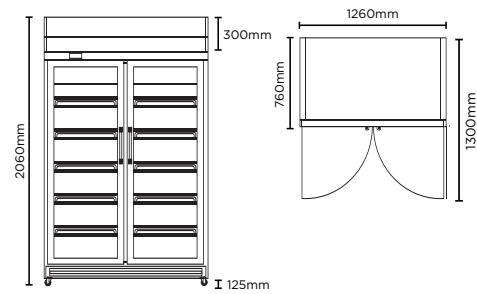

UF1000LF



Flat Glass Door 976L LED Display Freezer

Part No. 3736241 **Capacity** 976L **Weight** 199kg

	External (mm)	Internal (mm)
Width	1260	1143
Depth	760	550
Height	2060	1420

- Fan-forced refrigeration system
- Triple-glazed heated safety glass increases efficiency while reducing condensation
- Self-closing door with stay for easy stocking and hassle-free self service
- Temperature range: -22°C to -18°C

FF

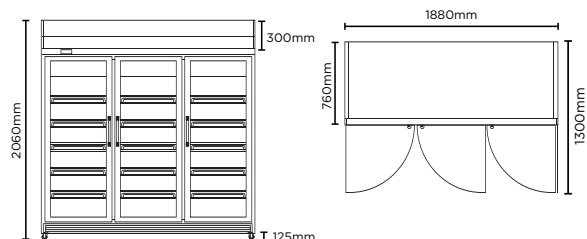

UF1500LF



Flat Glass Door 1507L LED Display Freezer

Part No. 3736242 **Capacity** 1507L **Weight** 279kg

	External (mm)	Internal (mm)
Width	1880	1755
Depth	760	550
Height	2060	1420

- Fan-forced refrigeration system
- Triple-glazed heated safety glass increases efficiency while reducing condensation
- Self-closing door with stay for easy stocking and hassle-free self service
- Temperature range: -22°C to -18°C

FF

Vertical Display & Storage

Upright Storage Freezers

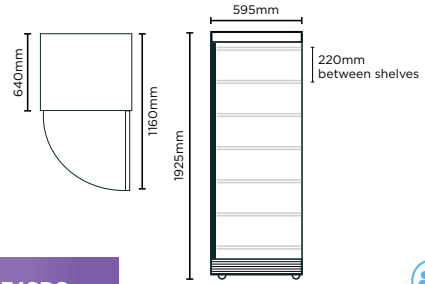

UF0374SDS



Solid Door 300L Storage Freezer

Part No.	Capacity	Weight
3735106	300L	79.5kg
External (mm)		Internal (mm)
Width	595	475
Depth	640	440
Height	1925	1550

- Lockable castors make movement and placement easy
- Solid insulated steel door minimises heat ingress
- Refrigeration integrated into all 6 fixed shelves for even cooling
- Temperature range: -19°C to -14°C

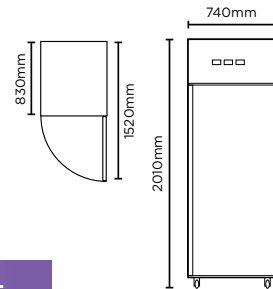

UF0650SDF



Gastronom Stainless Steel 650L Storage Freezer

Part No.	Capacity	Weight
3735203	650L	147kg
External (mm)		Internal (mm)
Width	740	624
Depth	830	685
Height	2010	1390

- Lockable castors make movement and placement easy
- Self-closing door provides hassle-free operation and energy efficiency
- Supplied with stainless steel rails and 5 shelves for use with 2/1 Gastronom trays
- Dixell digital controller for precise temperature maintenance
- Temperature range: -22°C to -18°C

FF

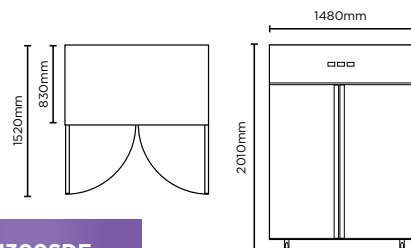

UF1300SDF



Gastronom Stainless Steel 1300L Storage Freezer

Part No.	Capacity	Weight
3735194	1300L	226kg
External (mm)		Internal (mm)
Width	1480	1360
Depth	830	685
Height	2010	1390

- Lockable castors make movement and placement easy
- Self-closing door provides hassle-free operation and energy efficiency
- Supplied with stainless steel rails and 10 shelves for use with 2/1 Gastronom trays
- Dixell digital controller for precise temperature maintenance
- Temperature range: -22°C to -18°C

FF

Vertical Display & Storage

Specification Reference Guide

Fridge

Freezer

Model	GM0220 LED	GM0300 LED	GM0374 LED	GM0374L LED	GM0374LB LED
Part Number	3736033	3736034	3736035	3736036	3736092
Ext. Width (mm)*	595	595	595	595	595
Ext. Depth (mm)*	640	640	640	640	640
Ext. Height (mm)*	1400	1725	1950	2100	2100
Capacity	215L	290L	372L	372L	372L
Temp. Range	+1 to +10°C	+1 to +10°C	+1 to +10°C	+1 to +10°C	+1 to +10°C
Max. Ambient Temp.	40°C	40°C	40°C	40°C	40°C
Rated Power	235W	290W	350W	370W	370W
Current	2.0A	2.0A	2.6A	2.7A	2.7A
Gross Weight	68kg	74kg	81kg	85kg	85kg
Refrigerant	R134a	R134a	R134a	R134a	R134a
Plug Supplied	1	1	1	1	1
Power Supply	10A	10A	10A	10A	10A
Features					
Fridge Case	✓	✓	✓	✓	✓
Freezer Case					
Display Light Box				✓	✓
Main Light	LED	LED	LED	LED	LED
Door Shape	Flat	Flat	Flat	Flat	Flat
Safety Glass	✓	✓	✓	✓	✓
Door Lock					
No. of Doors	1	1	1	1	1
Self-Closing Door	✓	✓	✓	✓	✓
Temp. Controller	Analogue	Analogue	Analogue	Analogue	Analogue
Castors	✓	✓	✓	✓	✓
No. of Shelves Incl. Base Per Door	4	5	6	6	6
Colour	White with Silver Trim	White with Silver Trim	White with Silver Trim	White with Silver Trim	White with Black Details
Warranty					
Parts (Years)	1	1	1	1	1
Labour (Years)	1	1	1	1	1

*Depth dimensions exclude lightbox & handle protrusions

Vertical Display & Storage

Specification Reference Guide

Fridge

Freezer

Model	GM0400LC LED	GM0440L LED	GM0690LW	GM0690LB	GM1000LBCAS	GM1000LWCAS
Part Number	3736037	3736038	3736219	3736222	3736251	3736250
Ext. Width (mm)*	595	680	780	780	1200	1200
Ext. Depth (mm)*	640	655	705	705	690	690
Ext. Height (mm)*	2100	2125	2185	2185	2080	2080
Capacity	380L	438L	659L	659L	960L	960L
Temp. Range	+1 to +10°C	+1 to +10°C	+1 to +5°C	+1 to +5°C	+2 to +5°C	+2 to +5°C
Max. Ambient Temp.	40°C	40°C	43°C	43°C	38°C	38°C
Rated Power	370W	390W	485W	485W	520W	520W
Current	2.7A	3.3A	3.8A	3.8A	2.3A	2.3A
Gross Weight	90kg	110kg	123kg	123kg	188kg	188kg
Refrigerant	R134a	R134a	R290a	R290a	R290	R290
Plug Supplied	1	1	1	1	1	1
Power Supply	10A	10A	10A	10A	10A	10A
Features						
Fridge Case	✓	✓	✓	✓	✓	✓
Freezer Case						
Display Light Box	✓	✓	✓	✓	✓	✓
Main Light	LED	LED	LED	LED	LED	LED
Door Shape	Curved	Flat	Flat	Flat	Flat	Flat
Safety Glass	✓	✓	✓	✓	✓	✓
Door Lock					✓	✓
No. of Doors	1	1	1	1	2	2
Self-Closing Door	✓	✓	✓	✓	✓	✓
Temp. Controller	Analogue	Analogue	Digital	Digital	Digital	Digital
Castors	✓	✓	✓	✓	✓	✓
No. of Shelves Incl. Base Per Door	6	6	6	6	6	6
Colour	White with Silver Trim	White with Stainless Steel Details	White	Black	Black	White
Warranty						
Parts (Years)	1	1	1	1	2	2
Labour (Years)	1	1	1	1	2	2

*Depth dimensions exclude lightbox & handle protrusions

Vertical Display & Storage

Specification Reference Guide

Fridge

Freezer

Model	SPECIAL ORDER		SPECIAL ORDER			
	GM0300 RETRO	WC0400C LED	GM0690-VID	GDO500LF	GD1000LF	GD1500LF
Part Number	3736079	3735145	3736093	3736245	3736246	3736247
Ext. Width (mm)*	595	595	780	635	1260	1880
Ext. Depth (mm)*	610	640	705	760	760	760
Ext. Height (mm)*	1720	1840	2080	2060	2060	2060
Capacity	290L	372L	657L	444L	976L	1507L
Temp. Range	+1 to +10°C	+1 to +18°C	+1 to +10°C	+2 to +8°C	+2 to +8°C	+2 to +8°C
Max. Ambient Temp.	40°C	40°C	32°C	38°C	38°C	38°C
Rated Power	290W	270W	485W	740W	1000W	1132W
Current	2.0A	1.8A	3.8A	4.5A	5.6A	7.0A
Gross Weight	85kg	84kg	136kg	95kg	157kg	209kg
Refrigerant	R134a	R134a	R134a	R134a	R134a	R134a
Plug Supplied	1	1	1	1	1	1
Power Supply	10A	10A	10A	10A	10A	10A
Features						
Fridge Case	✓	✓	✓	✓	✓	✓
Freezer Case						
Display Light Box			✓	✓	✓	✓
Main Light	LED	LED	LED	LED	LED	LED
Door Shape	Flat	Curved	TV	Flat	Flat	Flat
Safety Glass	✓	✓	✓	✓	✓	✓
Door Lock				✓	✓	✓
No. of Doors	1	1	1	1	2	3
Self-Closing Door	✓	✓	✓	✓	✓	✓
Temp. Controller	Analogue	Analogue	Digital	Digital	Digital	Digital
Castors	✓	✓	✓	✓	✓	✓
No. of Shelves Incl. Base Per Door	5	6	5	6	6	6
Colour	Black/Custom	Silver	Custom	White with Stainless Steel Trim	White with Stainless Steel Trim	White with Stainless Steel Trim
Warranty						
Parts (Years)	1	1	1	1	1	1
Labour (Years)	1	1	1	1	1	1

*Depth dimensions exclude lightbox & handle protrusions

Vertical Display & Storage

Specification Reference Guide

Fridge

Freezer





Model	GM0980LS LED	GM1000LW ECO	GM1000LB ECO	UC0374SDW	UC0650SD	UC1300SD
Part Number	3735048	3736252	3736253	3735127	3735161	3735200
Ext. Width (mm)*	1200	1200	1200	595	740	1480
Ext. Depth (mm)*	742	690	690	640	830	830
Ext. Height (mm)*	2000	1998	1998	1925	2010	2010
Capacity	945L	960L	960L	372L	650L	1300L
Temp. Range	+1 to +10°C	+1 to +10°C	+1 to +10°C	+1 to +10°C	+2 to +8°C	+2 to +8°C
Max. Ambient Temp.	40°C	38°C	38°C	40°C	38°C	38°C
Rated Power	850W	650W	650W	350W	360W	520W
Current	5.8A	4A	4A	2.6A	2.2A	4.2A
Gross Weight	210kg	177kg	177kg	88kg	143kg	213kg
Refrigerant	R134a	R290	R290	R134a	R134a	R134a
Plug Supplied	1	1	1	1	1	1
Power Supply	10A	10A	10A	10A	10A	10A
Features						
Fridge Case	✓	✓	✓	✓	✓	✓
Freezer Case						
Display Light Box	✓	✓	✓			
Main Light	LED	LED	LED	Fluorescent	LED	LED
Door Shape	Flat	Flat	Flat	Flat	Flat	Flat
Safety Glass	✓	✓	✓			
Door Lock		✓	✓		✓	✓
No. of Doors	2	2	2	1	1	2
Self-Closing Door	✓	✓	✓	✓	✓	✓
Temp. Controller	Digital	Analogue	Analogue	Analogue	Digital	Digital
Castors		✓	✓	✓	✓	✓
No. of Shelves Incl. Base Per Door	5	5	5	7	6	6
Colour	Black	White	Black	White with Black Details	Stainless Steel	Stainless Steel
Warranty						
Parts (Years)	1	1	1	1	2	2
Labour (Years)	1	1	1	1	2	2

Vertical Display & Storage

Specification Reference Guide

Fridge

Freezer

Model	UF0374S LED 	UF0374LS LED 	UF0440LS LED 	UF0500LF 	UF1000LF 
Part Number	3736045	3736046	3736047	3736240	3736241
Ext. Width (mm)*	595	595	680	635	1260
Ext. Depth (mm)*	620	620	655	760	760
Ext. Height (mm)*	1925	2100	2133	2060	2060
Capacity	300L	300L	440L	444L	976L
Temp. Range	-19 to -14°C	-19 to -14°C	-19 to -14°C	-22 to -18°C	-22 to -18°C
Max. Ambient Temp.	35°C	35°C	35°C	38°C	38°C
Rated Power	620W	635W	867W	1000W	1600W
Current	3.9A	4.1A	5.6A	4.7A	8A
Gross Weight	102kg	106kg	123kg	113kg	199kg
Refrigerant	R404a	R404a	R404a	R404a	R404a
Plug Supplied	1	1	1	1	1
Power Supply	10A	10A	10A	10A	10A
Features					
Fridge Case					
Freezer Case	✓	✓	✓	✓	✓
Display Light Box		✓	✓	✓	✓
Main Light	LED	LED	LED	LED	LED
Door Shape	Flat	Flat	Flat	Flat	Flat
Safety Glass	✓	✓	✓	✓	✓
Door Lock				✓	✓
No. of Doors	1	1	1	1	2
Self-Closing Door	✓	✓	✓	✓	✓
Temp. Controller	Analogue	Analogue	Analogue	Digital	Digital
Castors	✓	✓	✓	✓	✓
No. of Shelves Incl. Base Per Door	7	7	7	6	6
Colour	White with Silver Trim	White with Silver Trim	White with Silver Trim	White with Stainless Steel Trim	White with Stainless Steel Trim
Warranty					
Parts (Years)	1	1	1	1	1
Labour (Years)	1	1	1	1	1

Vertical Display & Storage

Specification Reference Guide

Fridge

Freezer

Model	UF1500LF	UF0374SDS	UF0650SDF	UF1300SDF
Part Number	3736242	3735106	3735203	3735194
Ext. Width (mm)*	1880	595	740	1480
Ext. Depth (mm)*	760	640	830	830
Ext. Height (mm)*	2060	1925	2010	2010
Capacity	1507L	300L	650L	1300L
Temp. Range	-22 to -18°C	-19 to -14°C	-22 to -18°C	-22 to -18°C
Max. Ambient Temp.	38°C	35°C	38°C	38°C
Rated Power	2000W	270W	640W	800W
Current	9A	2.4A	2.8A	4.8A
Gross Weight	279kg	79.5kg	147kg	226kg
Refrigerant	R404a	R404a	R404a	R404a
Plug Supplied	1	1	1	1
Power Supply	15A	10A	10A	10A
Features				
Fridge Case				
Freezer Case	✓	✓	✓	✓
Display Light Box	✓			
Main Light	LED	Fluorescent	LED	LED
Door Shape	Flat	Flat	Flat	Flat
Safety Glass	✓			
Door Lock	✓		✓	✓
No. of Doors	3	1	1	2
Self-Closing Door	✓	✓	✓	✓
Temp. Controller	Digital	Analogue	Digital	Digital
Castors	✓	✓	✓	✓
No. of Shelves Incl. Base Per Door	6	7	6	6
Colour	White with Stainless Steel Trim	White with Black Details	Stainless Steel	Stainless Steel
Warranty				
Parts (Years)	1	1	2	2
Labour (Years)	1	1	2	2